



Getting Started with HFSS: Floquet Ports



ANSYS, Inc.
Southpointe
2600 Ansys Drive
Canonsburg, PA 15317
ansysinfo@ansys.com
<https://www.ansys.com>
(T) 724-746-3304
(F) 724-514-9494

Release 2024 R2
July 2024

ANSYS, Inc. and ANSYS
Europe, Ltd. are UL registered
ISO 9001:2015 companies.

Copyright and Trademark Information

© 1986-2024 ANSYS, Inc. Unauthorized use, distribution or duplication is prohibited.

ANSYS, Ansys Workbench, AUTODYN, CFX, FLUENT and any and all ANSYS, Inc. brand, product, service and feature names, logos and slogans are registered trademarks or trademarks of ANSYS, Inc. or its subsidiaries located in the United States or other countries. ICM CFD is a trademark used by ANSYS, Inc. under license. All other brand, product, service and feature names or trademarks are the property of their respective owners. FLEXIm and FLEXnet are trademarks of Flexera Software LLC.

Disclaimer Notice

THIS ANSYS SOFTWARE PRODUCT AND PROGRAM DOCUMENTATION INCLUDE TRADE SECRETS AND ARE CONFIDENTIAL AND PROPRIETARY PRODUCTS OF ANSYS, INC., ITS SUBSIDIARIES, OR LICENSORS. The software products and documentation are furnished by ANSYS, Inc., its subsidiaries, or affiliates under a software license agreement that contains provisions concerning non-disclosure, copying, length and nature of use, compliance with exporting laws, warranties, disclaimers, limitations of liability, and remedies, and other provisions. The software products and documentation may be used, disclosed, transferred, or copied only in accordance with the terms and conditions of that software license agreement.

ANSYS, Inc. and ANSYS Europe, Ltd. are UL registered ISO 9001: 2015 companies.

U.S. Government Rights

For U.S. Government users, except as specifically granted by the ANSYS, Inc. software license agreement, the use, duplication, or disclosure by the United States Government is subject to restrictions stated in the ANSYS, Inc. software license agreement and FAR 12.212 (for non-DOD licenses).

Third-Party Software

See the legal information in the product help files for the complete Legal Notice for Ansys proprietary software and third-party software. If you are unable to access the Legal Notice, please contact ANSYS, Inc.

Conventions Used in this Guide

Please take a moment to review how instructions and other useful information are presented in this documentation.

- Procedures are presented as numbered lists. A single bullet indicates that the procedure has only one step.
- Bold type is used for the following:
 - Keyboard entries that should be typed in their entirety exactly as shown. For example, “**copy file1**” means you must type the word **copy**, then type a space, and then type **file1**.
 - On-screen prompts and messages, names of options and text boxes, and menu commands. Menu commands are often separated by greater than signs (>). For example, “click **HFSS > Excitations > Assign > Wave Port.**”
 - Labeled keys on the computer keyboard. For example, “Press **Enter**” means to press the key labeled **Enter**.
- Italic type is used for the following:
 - Emphasis.
 - The titles of publications.
 - Keyboard entries when a name or a variable must be typed in place of the words in italics. For example, “**copy filename**” means you must type the word **copy**, then type a space, and then type the name of the file.
- The plus sign (+) is used between keyboard keys to indicate that you should press the keys at the same time. For example, “Press Shift+F1” means to press the **Shift** key and, while holding it down, press the **F1** key also. You should always depress the modifier key or keys first (for example, Shift, Ctrl, Alt, or Ctrl+Shift), continue to hold it/them down, and then press the last key in the instruction.

Accessing Commands: *Ribbons*, *menu bars*, and *shortcut menus* are three methods that can be used to see what commands are available in the application.

- The *Ribbon* occupies the rectangular area at the top of the application window and contains multiple tabs. Each tab has relevant commands that are organized, grouped, and labeled. An example of a typical user interaction is as follows:

"Click **Draw > Line**"



This instruction means that you should click the **Line** command on the **Draw** ribbon tab. An image of the command icon, or a partial view of the ribbon, is often included with the instruction.

- The *menu bar* (located above the ribbon) is a group of the main commands of an application arranged by category such File, Edit, View, Project, etc. An example of a typical user interaction is as follows:

"On the **File** menu, click the **Open Examples** command" means you can click the **File** menu and then click **Open Examples** to launch the dialog box.

- Another alternative is to use the *shortcut menu* that appears when you click the right-mouse button. An example of a typical user interaction is as follows:

"Right-click and select **Assign Excitation > Wave Port**" means when you click the right-mouse button with an object face selected, you can execute the excitation commands from the shortcut menu (and the corresponding sub-menus).

Getting Help: Ansys Technical Support

For information about Ansys Technical Support, go to the Ansys corporate Support website, <http://www.ansys.com/Support>. You can also contact your Ansys account manager in order to obtain this information.

All Ansys software files are ASCII text and can be sent conveniently by e-mail. When reporting difficulties, it is extremely helpful to include very specific information about what steps were taken or what stages the simulation reached, including software files as applicable. This allows more rapid and effective debugging.

Help Menu

To access help from the Help menu, click **Help** and select from the menu:

- **[product name] Help** - opens the contents of the help. This help includes the help for the product and its *Getting Started Guides*.
- **[product name] Scripting Help** - opens the contents of the *Scripting Guide*.
- **[product name] Getting Started Guides** - opens a topic that contains links to Getting Started Guides in the help system.

Context-Sensitive Help

To access help from the user interface, press **F1**. The help specific to the active product (design type) opens.

You can press **F1** while the cursor is pointing at a menu command or while a particular dialog box or dialog box tab is open. In this case, the help page associated with the command or open dialog box is displayed automatically.

Table of Contents

Table of Contents	Contents-1
1 - Introduction	1-1
General Outline	1-1
Floquet Ports in HFSS	1-1
2 - Array Antenna	2-1
Set Units, Options, and Solution Type	2-3
Enable Legacy View Orientations	2-5
Create Unit Cell Model	2-7
Assign Primary and Secondary Boundaries (for Array)	2-8
Direction of the U-V Vectors	2-15
Assign Wave Port	2-15
Assign Floquet Port	2-18
Floquet Port Dialog Box	2-22
Add Solution Setup	2-24
Run Simulation and View Results	2-25
Create Variables for Scan Angles	2-27
Use Scan Angles for the Model	2-28
Set Up Parametric Sweep of Scan Angle	2-29
Set Up Modes for Parametric Sweep	2-31
Mode Selection	2-34
View Parametric Sweep Results	2-36
3 - Frequency Selective Surface Model	3-1
Sample Project – FSS	3-1
Set Units, Options, and Solution Type	3-3
Create the Rhombic Sheet	3-5
Transform 2-D Sheet into a 3D Cell Object	3-8
Create the Aperture Object	3-9
Reposition the 3D Cell	3-12

Assign Primary and Secondary Boundaries	3-13
Assign the Perfect E Boundary	3-16
Assign the Floquet Ports	3-16
Set Up the Analysis	3-21
Add Frequency Sweep and Analyze	3-22
Evaluate the Results	3-26
Phase Transmission vs. Frequency	3-26
S Parameters vs. Frequency	3-28
Port Field Displays for Modes	3-30
4 - Optionally, Restore Current View Orientations	4-1

1 - Introduction

This document is intended as supplementary material to HFSS users. We assume you have some experience of designing projects using HFSS. The document includes instructions to create, solve, and analyze results of models that are excited with Floquet ports.

This chapter contains the following topics:

- General Outline
- Floquet Ports in HFSS

General Outline

For the projects described in this guide, you will perform the following tasks in HFSS:

- Create the geometric models.
- Modify the models' design parameters.
- Specify solution setup and sweep for the designs.
- Validate the design setups.
- Run HFSS simulations.
- Create 2D x-y plots of S-parameter results.

Floquet Ports in HFSS

The Floquet port in HFSS is used exclusively with planar-periodic structures. Chief examples are planar phased arrays and frequency selective surfaces when these may be idealized as infinitely large. The analysis of the infinite structure is then accomplished by analyzing a unit cell. Linked boundaries most often form the side walls of a unit cell, but in addition, a boundary condition is required to account for the infinite space above. The Floquet port is designed for this purpose.

The Floquet port is closely related to a Wave port in that a set of modes ("Floquet modes") represents the fields on the port boundary. Fundamentally, Floquet modes are plane waves with propagation direction set by the frequency, phasing, and geometry of the periodic structure. Just like Wave modes, Floquet modes too have propagation constants and experience cut-off at low frequency.

When a Floquet port is present, the HFSS solution includes a modal decomposition that gives additional information on the performance of the radiating structure. As in the case of a Wave port, this information is cast in the form of an S-matrix interrelating the Floquet modes. In fact, if Floquet ports and Wave ports are simultaneously present, the S-matrix will interrelate all Wave modes and all Floquet modes in the project.

For the current version, the following restrictions apply:

- Currently, only modal projects may contain Floquet ports.
- Boundaries that are adjacent to a Floquet port must be linked boundaries.
- Fast frequency sweep is not supported. (Discrete and interpolating sweep are supported.)

2 - Array Antenna

This chapter contains the following topics:

- Sample Project - Array Antenna
- Set Units, Options, and Solution Type
- Create Unit Cell Model
- Assign Primary and Secondary Boundaries
- Assigning Wave Port
- Assign Floquet Port
 - Floquet Port Dialog Box
- Add Solution Setup
- Run Simulation and View Results
- Create Variables for Scan Angles
- Use Scan Angles for the Model
- Set Up Parametric Sweep of Scan Angle
 - Set up Modes for Parametric Sweep
 - Mode Selection
- View Parametric Sweep Results

Sample Project – Array Antenna

The Array Antenna figure below illustrates an infinite array of square aperture antennas in a conducting plane. The elements are fed from below the plane by square waveguide ports with dominant modal field aligned in the direction shown.

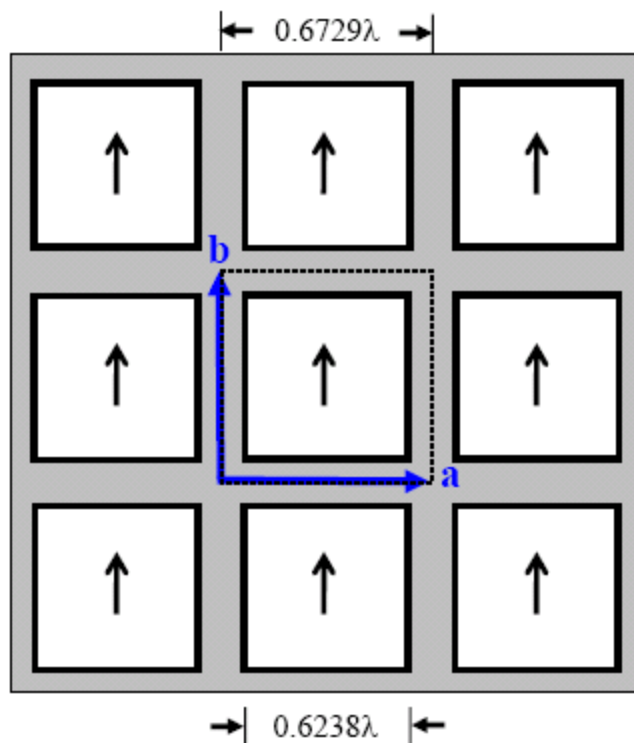

Figure 2-1: Array Antenna

When the elements are uniformly excited so that the array radiates in the broadside direction, the field above the array is periodic. The relative positions of the periodic points where field values are equal may be specified by a pair of vectors, shown in blue and denoted by a and b . These "lattice vectors" describe the geometry of the array but are independent of the nature of the array elements themselves. The lattice vectors may be parallel-transported anywhere in the array plane to show corresponding field points.

In the usual way, a unit cell may be analyzed to represent the entire array and the outline of one possible unit cell is shown in the Array Antenna figure using dotted lines.

The following figure depicts an HFSS model for the unit cell of the infinite array. The model consists of two boxes. The lower box represents the feeding waveguide and the top box is the unit cell for the region above the plane. The dimensions and geometry of the unit cell reflect the lattice vectors of the array. Linked boundaries are defined on the cell walls and a Wave port provides the array element excitation.

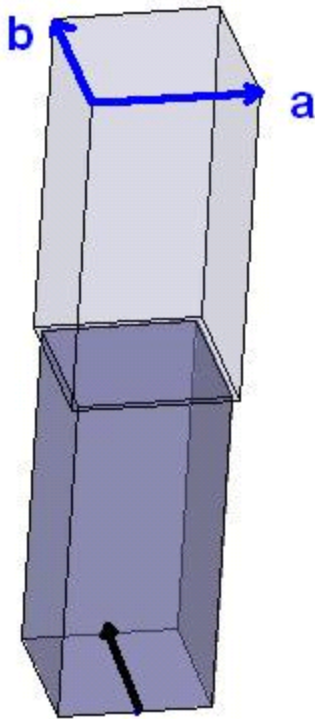



Figure 2-2: HFSS Model of Unit Cell with Lattice Vectors

Note:

A Floquet port is used on the (top) open boundary.

Set Units, Options, and Solution Type

Define the name, options, design type, units, and solution type for this project before you build the model.

1. Launch *Ansys Electronics Desktop* and name a new project **RhombicArray** (by renaming *Projectx* at the top of the Project Manager).
2. On the **Desktop** ribbon tab, click  **General Options**.
 - a. In the tree on the left side of the *Options* dialog box, select the **3D Modeler > Drawing** group.
 - b. Clear the **Edit properties of new primitives** option, if it is selected.

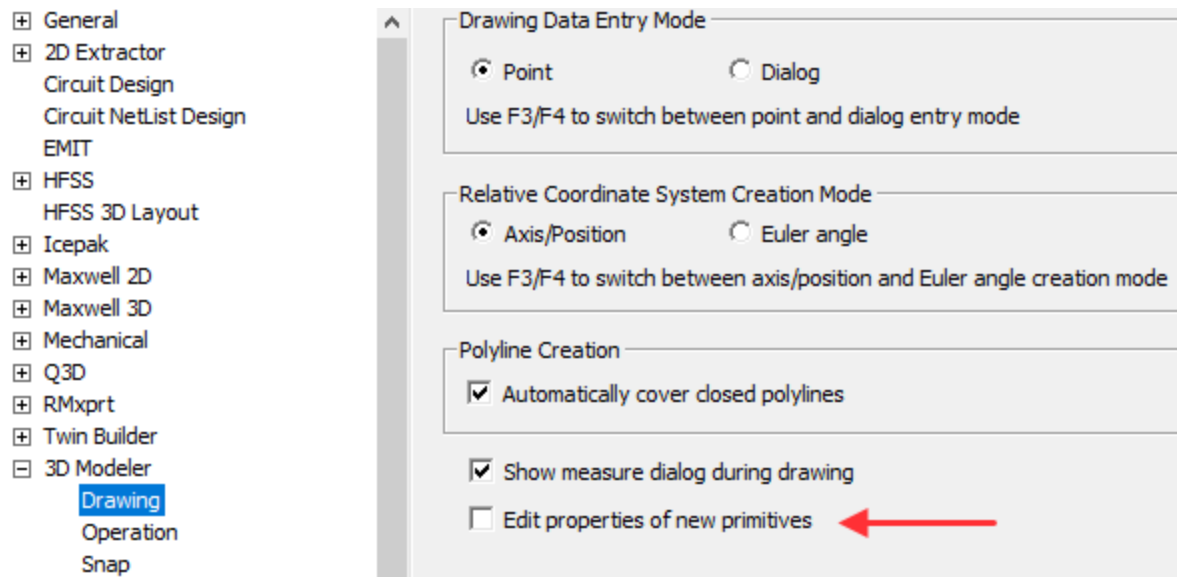



Figure 2-3: Options Dialog Box – 3D Modeler > Drawing Group

Note:

In other HFSS getting started guides, this option has been selected, and you've used the pop-up *Properties* dialog box to edit the parameters of newly drawn objects. For this exercise, the *Properties* dialog box will **not** appear when you draw a new object. Instead, you will use the docked *Properties* window (located beneath the Project Manager by default) to edit the properties of new objects.

c. Click **OK**.

3. On the **Desktop** ribbon tab, click  **Insert HFSS design**. (You do not have to access the drop-down menu. The default menu action is to insert a conventional HFSS design.)
4. On the **Draw** ribbon tab, click **Units**, choose **meter** from the **Select Units** drop-down menu, and click **OK**.
5. From the menu bar, click **HFSS > Solution Type**.

The *Solution Type* dialog box appears.

6. Under *Options*, select **Modal** and also ensure that the remaining settings are as shown in the following image:

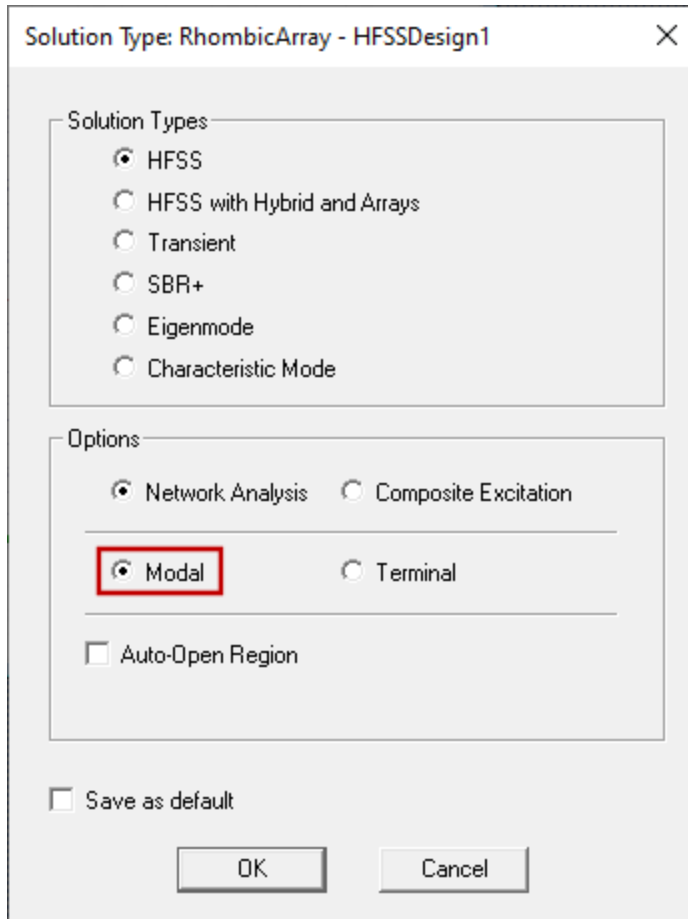

Figure 2-4: Solution Type Dialog Box

7. Click **OK**.

Enable Legacy View Orientations

This getting started guide was created based on standard view orientations that were in effect for version 2023 R2 and earlier of the Ansys Electronics Desktop application. For consistency between your experience and the views and instructions contained in this guide, select the *Enable Legacy View Orientation* option in the 3D UI Options dialog box, as follows:

1. From the menu bar, click **View > Options**.
The *3D UI Options* dialog box appears.
2. Select **Enable Legacy View Orientation**:

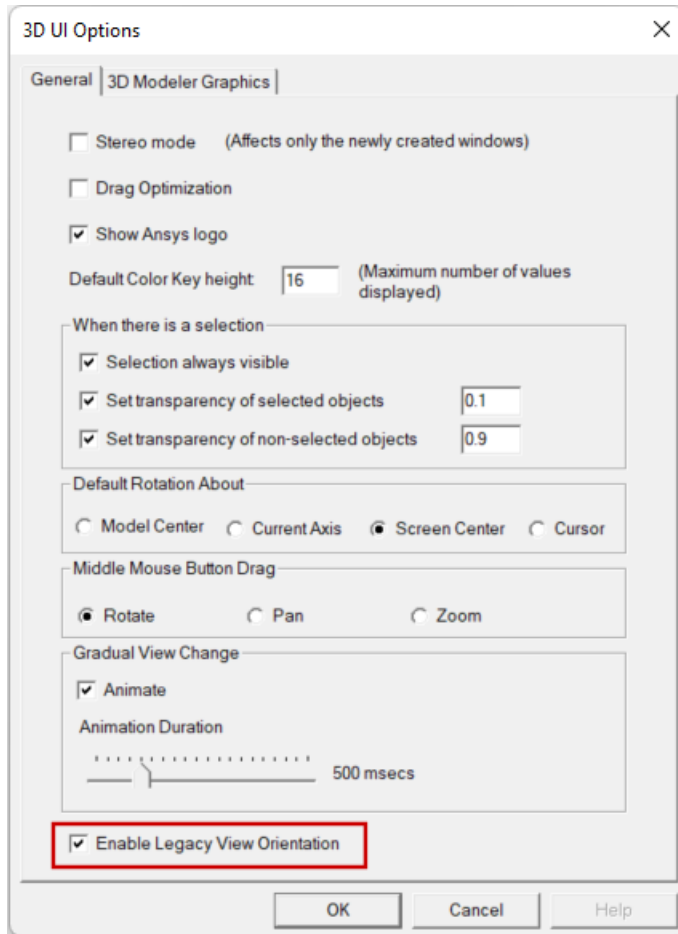

3. Click **OK**.

Changing the view orientation option does not change the model viewpoint that was in effect at the time.

4. On the **Draw** ribbon tab, click  **Orient** to change to the *Trimetric* view, which is the default legacy view orientation.

You do not have to select *Trimetric* from the *Orient* drop-down menu. The default view appears when you click *Orient*.

Although this option can only be accessed once a design is added to a project, it is a global option. Your choice is retained for all future program sessions, projects, and design types that use the 3D Modeler or that produce 3D plots of results.

At the end of this guide, you will be prompted to clear the *Enable Legacy View Orientation* option, if you prefer to use the view orientation scheme implemented for 2024 R1 and newer versions going forward.

For a comparison of the legacy and current view orientations, search for "*View Options: 3D UI Options*" in the HFSS help. Additionally, views associated with **Alt + double-click** zones have

been redefined. The current orientations are shown in the help topic, "*Changing the Model View with Alt+Double-Click Areas.*"

Create Unit Cell Model

1. On the **Draw** ribbon tab, click  **Draw box** and press **F3** to ensure that you are using the graphical drawing mode.
2. Click at three different locations in the Modeler window to graphically create an arbitrary box. Then, define the values in the **Command** tab of the docked *Properties* window, as shown in the following figure:

	Name	Value	Unit	Evaluated Value
	Command	CreateBox		
	Coordinate Sys...	Global		
	Position	-0.33645 , -0.33645 , 0	meter	-0.33645meter , -0.33645meter , 0meter
	XSize	0.6729	meter	0.6729meter
	YSize	0.6729	meter	0.6729meter
	ZSize	1.4	meter	1.4meter

Figure 2-5: Properties of Box1 – Command Tab

Do not clear the selection yet.

3. In the **Attribute** tab of the docked *Properties* window, make the following changes:
 - a. Ensure that **Material Appearance** is not selected.
 - b. Change the **Color** to **Blue-Gray** (column 7, row 2 of color swatches; Red: 128, Green: 128, Blue: 192).
 - c. Set the **Transparent** value to **0.8**.
4. Again click  **Draw box** on the **Draw** ribbon tab.
5. Create another arbitrary box. Then, define the values in the **Command** tab of the docked *Properties* window, as shown in the following figure:

	Name	Value	Unit	Evaluated Value
	Command	CreateBox		
	Coordinate Sys...	Global		
	Position	-0.3119 , -0.3119 , 0	meter	-0.3119meter , -0.3119meter , 0meter
	XSize	0.6238	meter	0.6238meter
	YSize	0.6238	meter	0.6238meter
	ZSize	-1.4	meter	-1.4meter

Figure 2-6: Properties of Box2 – Command Tab

6. In the **Attribute** tab of the docked *Properties* window, make the following changes:

- a. Ensure that **Material Appearance** is not selected.
 - b. Change the **Color** to **Blue-Gray** (column 7, row 2 of color swatches; Red: 128, Green: 128, Blue: 192).
 - c. Set the **Transparent** value to **0.5**.
7. Click in the Modeler window background to clear the selection and press **Ctrl+D** to fit the view.

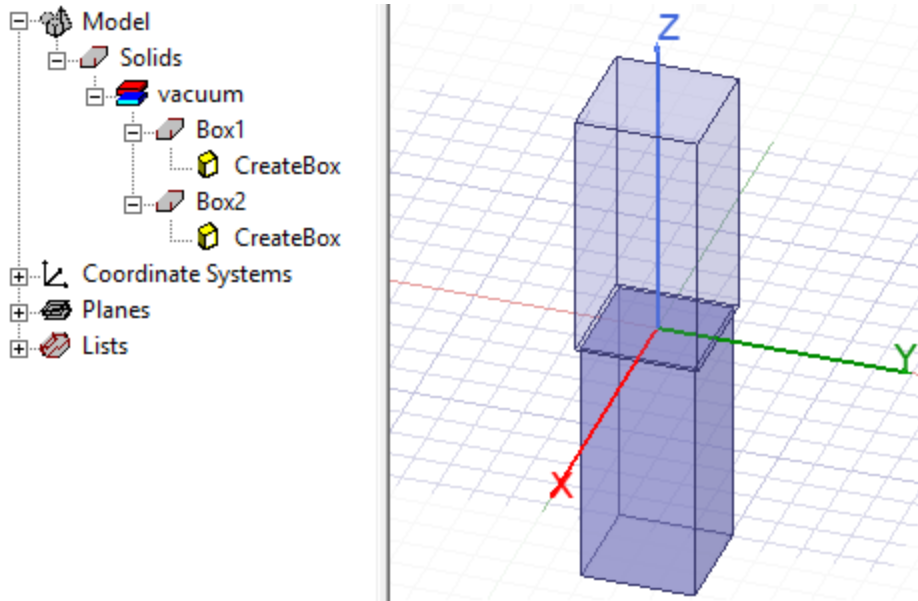

Figure 2-7: The Unit Cell Model

Assign Primary and Secondary Boundaries (for Array)

Assign boundaries to the *Box1* object as follows:

1. Press **F** to start the *Face* selection mode.
2. Select the face on the **+X** side of the top box (*Box1*). See [U Vector Drawn](#).
3. From the menu bar, click **HFSS > Boundaries > Assign > Coupled > Primary**.

The *Primary Boundary* dialog box appears.

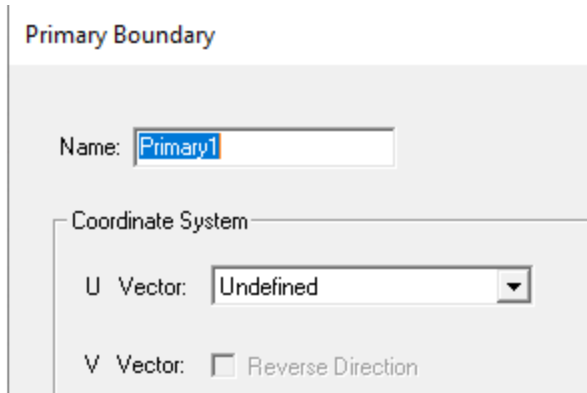

Figure 2-8: Primary Boundary Dialog Box

Note:

Leave the default **Name** as *Primary1*.

4. Select **New Vector** from the **U Vector** drop-down menu.

The *Measure Data* and *Create Line* dialog boxes appear.

Note:

The *Measure Data* dialog box will show up only if you have selected **Show measure dialog during drawing** in the *3D Modeler > Drawing* group of the *Options* dialog box. You can access the *Options* dialog box by pressing **General Options** on the **Desktop** ribbon tab.

5. Click (snap to) the lower-right corner of the face and then click on the lower-left corner to draw the U vector (red arrow). The vector runs along the bottom edge of the selected face and points from right to left (in the global -Y direction), as shown in the following image:

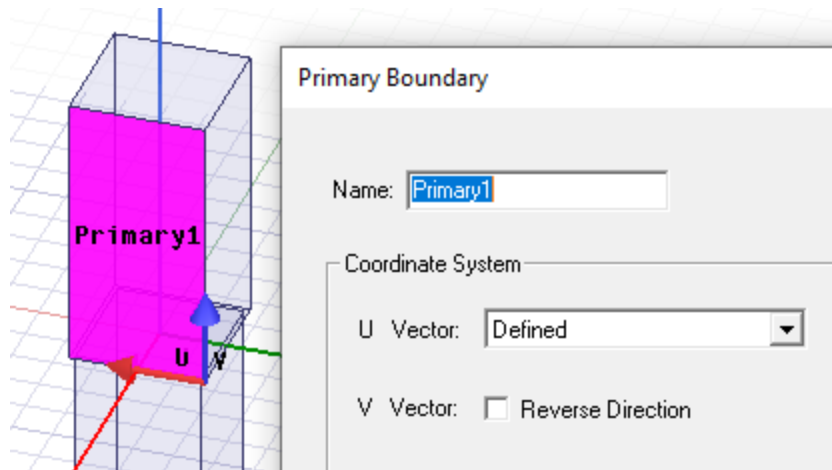

Figure 2-9: U Vector Drawn

Note:

Once you click the second point, the *U Vector* field in the *Primary Boundary* dialog box should now indicate *Defined*.

6. Click **OK** to assign the primary boundary.
7. If the boundary visualization is not displayed, select **Primary1** under *Boundaries* in the Project Manager.

Your model should look like the following figure:

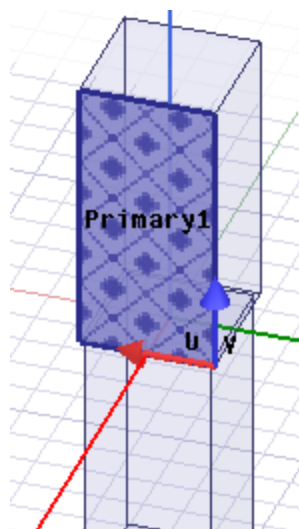

Figure 2-10: *Primary1* Boundary Assigned

Keep the boundary selected, which will help you visualize the model orientation in the next step.

- While holding down the **Z** key, click and drag using the **middle** mouse button to **rotate** the model viewpoint approximately 180 degrees about the Z axis. Do this by dragging the cursor in a semi-circular path around the screen center. A 180-degree arc will produce 180 degrees of view rotation.

If you don't have a three-button mouse, and you have **Enable Legacy View Navigation** selected in your [User Interface Options](#) (which is selected by default), then: **Alt + click** (using the **left** mouse button) to provide the same rotational control via dragging.

Position the model for good access to the -X face of the top box, where you will next apply the secondary boundary.

- Select the face on the -X side of the top box.

Note:

Alternatively, without rotating the model viewpoint (step 8), you could initially select a face in the foreground and then press **B** (next Behind) to select the desired hidden face. Since you can easily select vertices behind objects, this method won't impede the vector definition for the secondary boundary, though a vector on the back side of the model would be less visible.

- On the toolbar, click **HFSS > Boundaries > Assign > Coupled > Secondary**.

The *Secondary: General Data* dialog box appears.

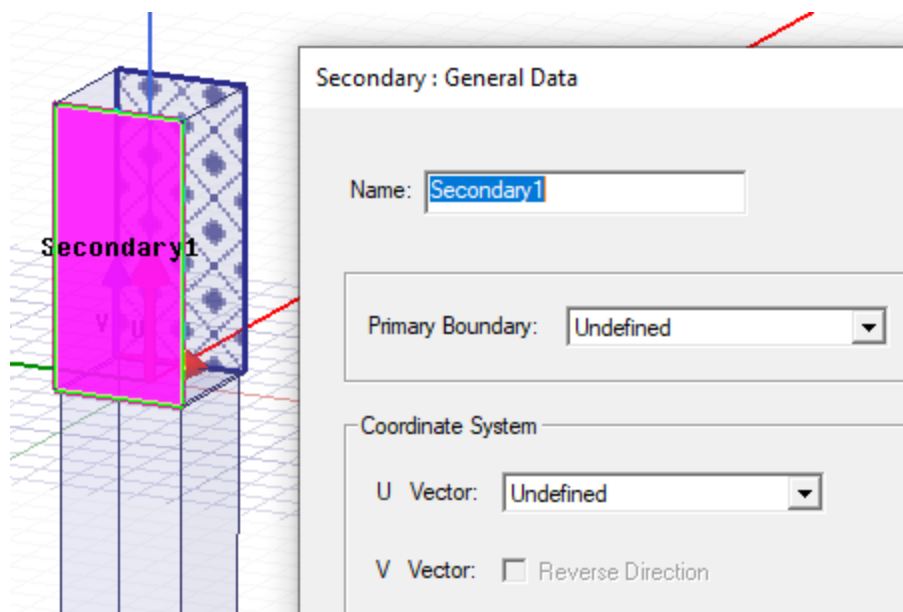

Figure 2-11: Assigning *Secondary1* Boundary to Back Face

11. Select **Primary1** from the **Primary Boundary** drop-down menu.
12. Select **New Vector** from the **U Vector** drop-down menu.

The *Measure Data* and the *Create Line* dialog boxes appear.

13. Click (snap to) the lower-left corner of the selected face and then click the lower-right corner. The U Vector runs along the bottom edge of the selected face and points in the -Y global direction.

Note:

The U and V vector directions must be the same for the Primary and its corresponding Secondary.

The *Secondary: General Data* dialog box reappears with the *U Vector* now *Defined*. Notice that the **Reverse Direction** option has been selected automatically to make the V Vector of the Secondary boundary consistent with the direction of the corresponding Primary boundary vector. Otherwise, the Secondary V Vector would be pointing in the opposite direction (correct axis but wrong sign).

Note:

Leave the **Name** as **Secondary1**.

14. Click **Next**.

The *Secondary: Phase Delay* dialog box appears.

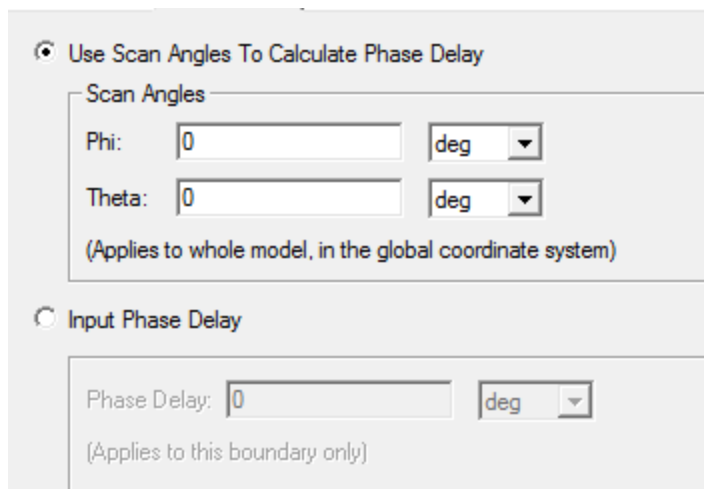

Figure 2-12: *Secondary: Phase Delay* Dialog Box

- Accept the default phase delay settings and click **Finish**.

The *Secondary1* boundary is assigned.

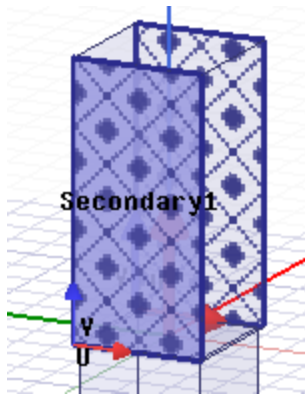

Figure 2-13: *Secondary1* Boundary is Assigned

- Select the -Y face of the top box (to the right side of *Secondary1*, as currently viewed). Then, right-click and choose **Assign Boundary > Coupled > Primary** from the short-cut menu.

The *Primary Boundary* dialog box appears.

- Select **New Vector** from the *U Vector* drop-down menu.
- Click (snap to) the lower-left corner of the selected face and then click the lower-right corner of the same face to draw the U Vector. The vector runs along the bottom edge of the selected face and points in the +X global direction.

Reverse direction is automatically selected.

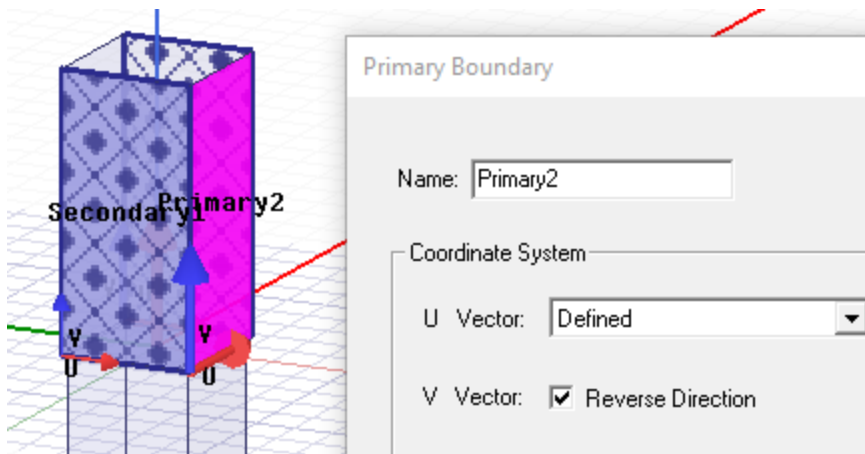



Figure 2-14: *Primary2*, V Vector Pointing Up

- Click **OK**.

The boundary *Primary2* is applied.

20. On the **Draw** ribbon tab, click  **Orient** to restore the default Trimetric view of the model.
21. Select the +Y face of the top box (opposite side from *Primary2*).
22. Right-click and choose **Assign Boundary > Coupled > Secondary**.

The *Secondary: General Data* dialog box appears.

23. Choose **Primary2** from the **Primary Boundary** drop-down menu.
24. Choose **New Vector** from the **U Vector** drop-down menu.

The *Create Line* and *Measure Data* dialog boxes appear.

25. Click (snap to) the lower-right corner of the selected face and then click on the lower-left corner of the face. The U Vector runs along the bottom edge of the selected face and points in the +X global direction. Also, the V Vector is correct and does not need to be reversed.

The *Secondary: General Data* dialog box reappears.

26. Click **Next**.

The *Secondary: Phase Delay* dialog box appears.

27. Accept the default phase delay settings and click **Finish**.

The *Secondary2* boundary is assigned.

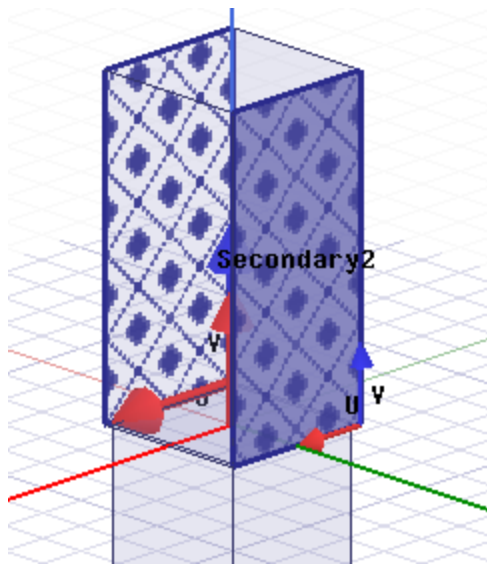

Figure 2-15: Primary2 and Secondary2 Boundaries Assigned

28. Click in the Modeler window's background area to clear the selected boundaries and face.

Direction of the U-V Vectors

HFSS uses the U and V vectors to set up a local co-ordinate system. A point on the Primary boundary must correspond to one on the Secondary. A point on the Secondary needs to be paired with the Primary so that a one-to-one correspondence can be established. Such a coordinate system should be constructed and aligned properly, in the same directions, so that the mapping is accomplished successfully. Additionally, both vectors should point into the boundary face from a perimeter edge or vertex. Therefore, when the V Vector is directed downwards in this exercise (away from the face), you must select the **Reverse Direction** option to keep it on the selected boundary face of the box, and not pointing outside of it.

Assign Wave Port

HFSS offers two methods of specifying mode alignment and polarity for wave port excitations:

- Specify an integration line to either set the mode polarity or align the modes.
- Align the modes analytically using a local coordinate system based on U and V axes you define.

When assigning a wave port, HFSS displays a *Wave Port: Modes* dialog box with options to help set up the **Mode Alignment and Polarity**. A portion of this dialog box is shown below:

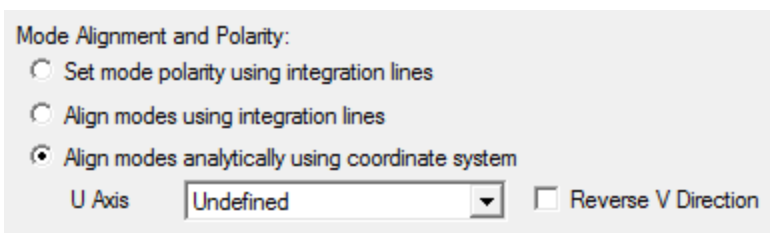

Figure 2-16: Portion of the *Wave Port: Mode* Dialog Box

For this particular design (that is, a cell model with emphasis on Floquet ports), we recommend you assign the Wave port with *analytical mode alignment*. Therefore, you should select the third option under *Mode Alignment and Polarity* for this project (as shown in the preceding figure).

Note:

For more information, search for "*Wave Port*" in the program help.

Assign Wave Port with Analytical Mode Alignment

You will assign a Wave Port boundary to the bottom face of the feeding waveguide for the purpose of injecting energy into the array element.

1. Click near the bottom of the +X face of the bottom box. Then, press **B** to select the bottom face. (See [Wave Port Assigned on Bottom Face](#).)
2. Right-click, and from the shortcut menu, select **Assign Excitation > Port > Wave Port**.

The *Wave Port: General* dialog box appears.

3. Make the following entries:
 - a. **Name = Waveport**
 - b. **Number of Modes = 2**

Note:

Because the feeding waveguide has a square cross-section, two waveguide modes must be specified.

- c. Select **Align Modes analytically using co-ordinate system** option.
- d. From the **U Axis** drop-down menu, select **New Vector**.

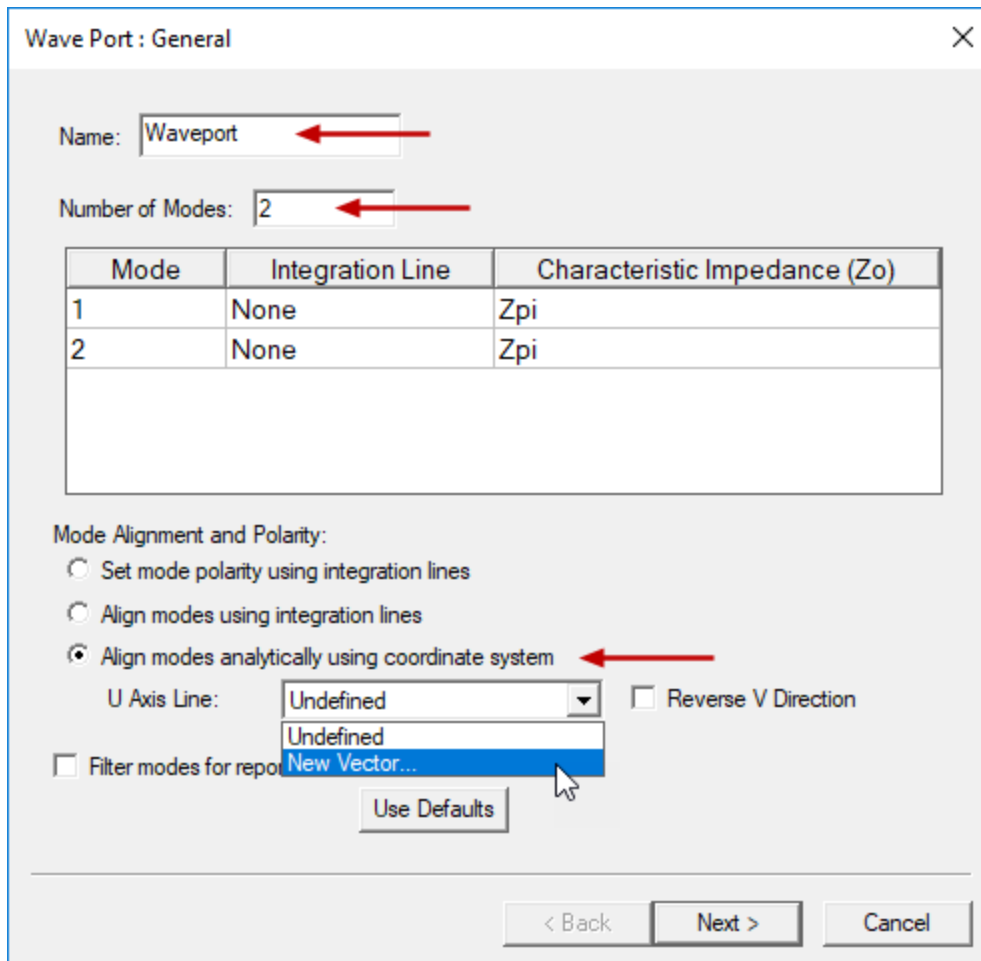

Figure 2-17: Wave Port: Modes Dialog Box

The cursor with a dotted line appears.

4. Define the U Axis as follows:

- a. Click the midpoint of the -Y edge of the bottom face. A small opaque triangle appears to indicate the midpoint snapping location.

After you click, a small local pair of mini axes appear at the midpoint, one running along the edge and one running across the middle of the selected face.

- b. Click the midpoint of the opposite (+Y) edge of the bottom face, specifying a U Axis that is parallel to the global Y axis and also pointing in the same direction.

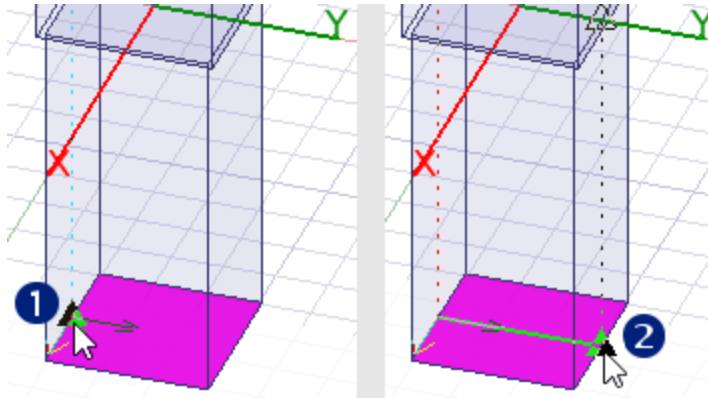

Figure 2-18: Defining the U Axis

5. Select **Reverse V Direction** so that the V Axis points in the same direction as the global X Axis.
6. Click **Next**.

The *Wave Port: Post Processing* dialog box appears.

7. Accept the default settings and click **Finish** to complete the wave port assignment.
8. If the wave port visualization is not currently displayed, select **Waveport** under *Excitations* in the Project Manager.

Your model should look like the following figure:

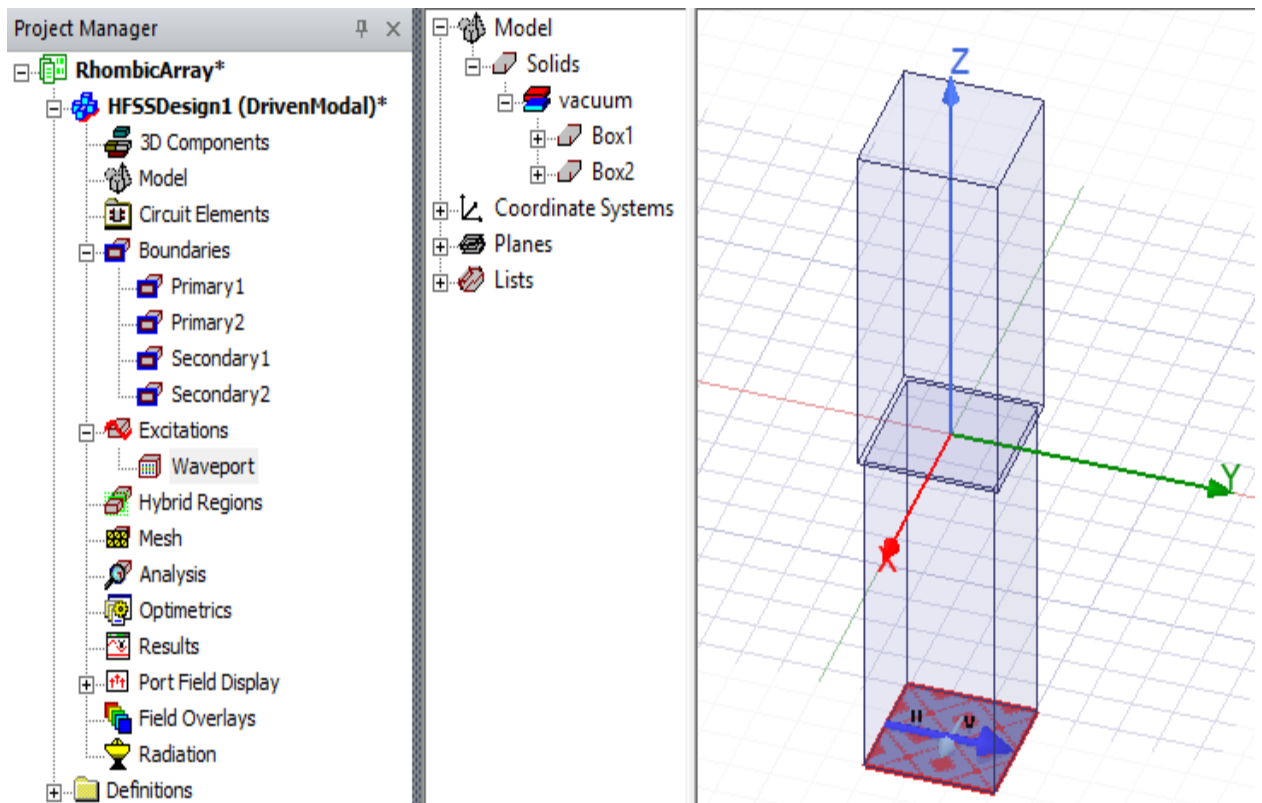

Figure 2-19: Wave Port Assigned on Bottom Face

9. Clear the selection.

Assign Floquet Port

To assign the Floquet port perform the following steps.

1. Select the top face of the upper box.
2. Right-click, and select **Assign Excitation > Port > Floquet Port** from the shortcut menu.

The *Floquet Port: General* dialog box appears, and the top face is labeled as *FloquetPort1*:

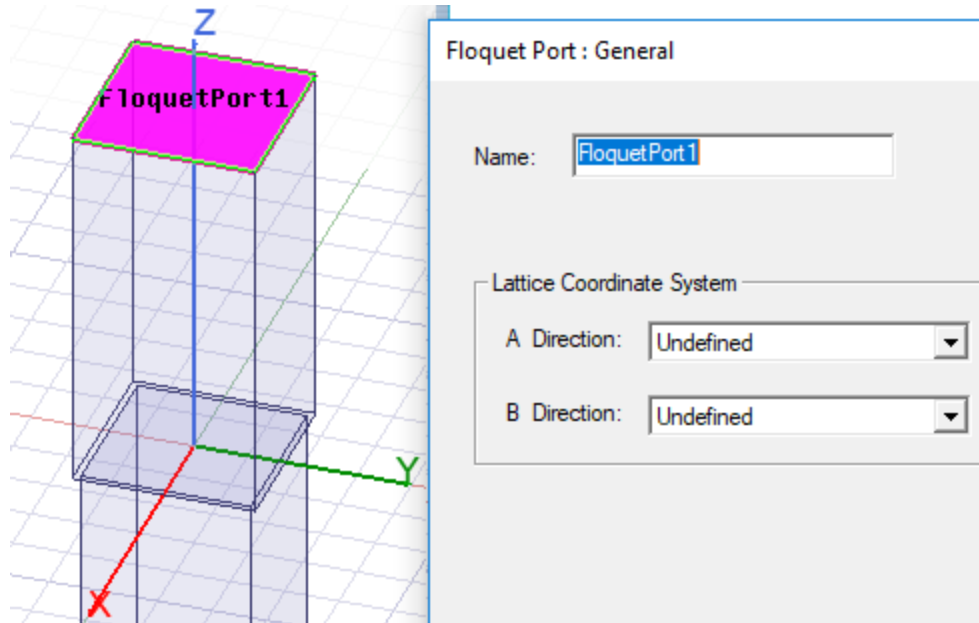

Figure 2-20: Selected Face and *Floquet Port: General* Dialog Box

- Under *Lattice Coordinate System*, select **New Vector** from the **A Direction** drop-down menu.

The cursor with a dotted line appears on the Modeler window.

- From the $-X$, $-Y$ corner of the top face, draw the *A Direction* vector parallel to, and in the same direction as, the X -axis.

The **a** vector is drawn and the *Floquet Port: General* dialog box reappears.

- Select **New Vector** from the **B Direction** drop-down menu.
- Draw the *B Direction* vector from the same $-X$, $-Y$ corner, perpendicular to the **a** vector, and pointing in the same direction as the $+Y$ global axis.

Note:

The lattice vectors **a** and **b** must have a common origin.

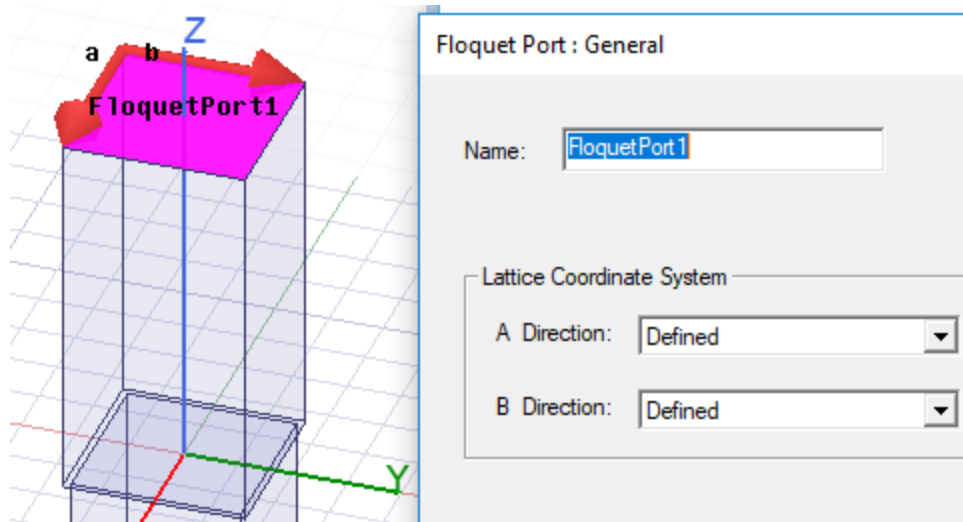

Figure 2-21: Floquet Port A and B Vectors Defined

After clicking the second point, the *Floquet Port: General* dialog box reappears, and both vectors now indicate *Defined*.

7. Click **Next**.

The *Floquet Port: Modes Setup* dialog box appears:

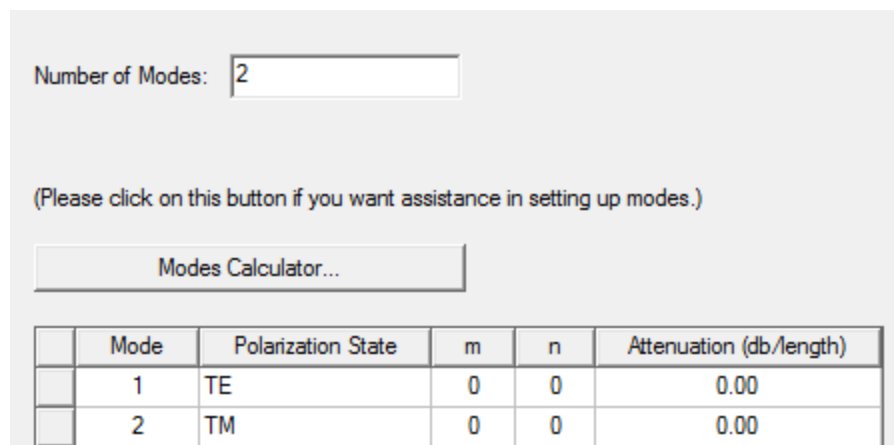

Figure 2-22: Floquet Port: Modes Setup Dialog Box

8. Keep the default settings and click **Next**.

The *Floquet Port: Post Processing* dialog box appears:

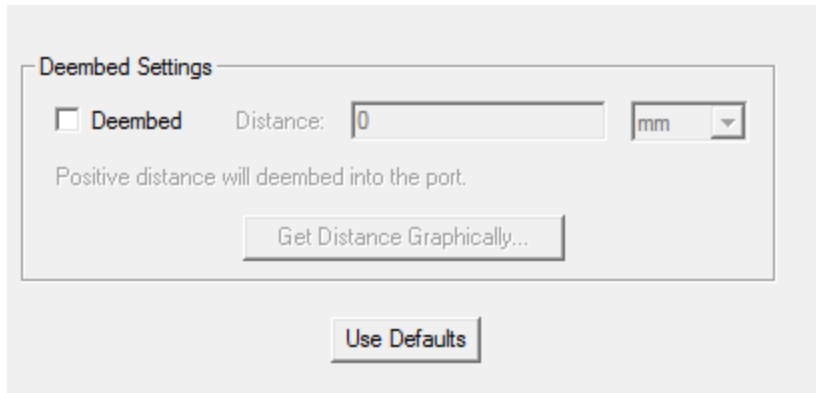

Figure 2-23: Floquet Port: Post Processing Dialog Box

9. Verify that the **Deembed** option is **not** selected and click **Next**.

The *Floquet Port: 3 D Refinement* dialog box appears:

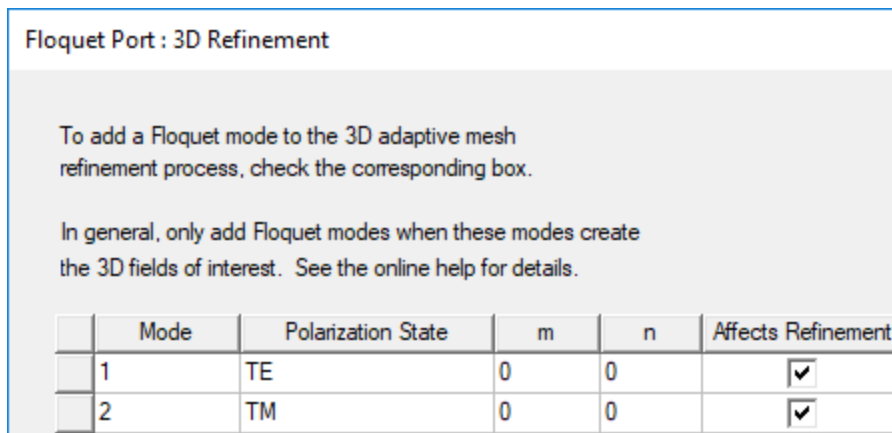

Figure 2-24: Floquet Port: 3-D Refinement

10. Accept the default settings and click **Finish**.

The Floquet port is assigned and *FloquetPort1* appears in the Project Manager window under *Excitations*:

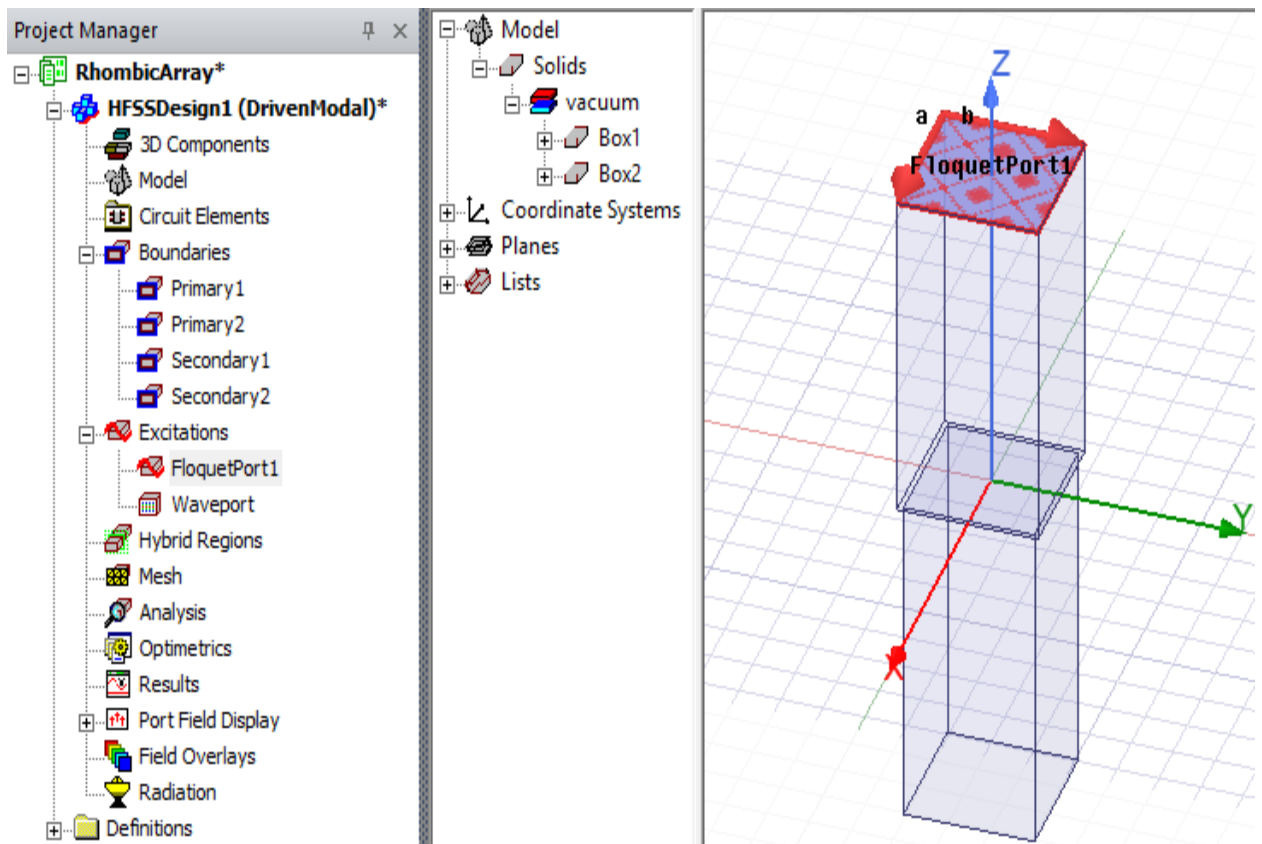

Figure 2-25: Floquet Port Assigned

Floquet Port Dialog Box

While assigning the Floquet Ports in this exercise, a wizard stepped you through the four phases of setting up the port. You used the options available on the *Floquet Port: General* dialog box and accepted default settings for the other three (*Modes Setup*, *Post Processing*, and *3D Refinement*).

If you double-click a previously defined port in the Project Manager to review or modify its settings, a unified *Floquet Port* dialog box appears having tabs for each of the four separate aspects of defining the port:

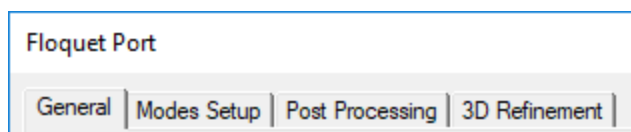

Figure 2-26: Floquet Port Dialog Box Tabs

The settings on the *Modes Setup*, *Post Processing*, and *3D Refinement* tabs are described below.

Floquet Port: Mode Setup

See [Floquet Port: Modes Setup Dialog Box](#). Floquet modes are specified by two modal indices and a polarization setting. These designations resemble the textbook notation for rectangular waveguide modes, such as "TE₁₀." The Floquet field patterns are different, however.

The Floquet modes in the modes table both have modal indices m and n equal to zero. They are sometimes called "specular" modes. In this project, the specular modes consist of two orthogonally-polarized plane waves propagating normal to the plane of the array.

Specular modes are always an essential part of the Floquet mode set. However, sometimes, due to electrical symmetry, one of the two polarizations may be omitted.

The final column of the mode table is labeled *Attenuation*. The attenuation of the mode is measured in the direction normal to the plane of the array.

The value given for the specular modes is 0 dB since they are propagating. Higher-order modes will experience attenuation if they are cut off. The value of attenuation is greater than zero.

Note:

The default specular pair of modes is sufficient for this simulation.

Floquet Port: Post Processing

See [Floquet Port: Post Processing Dialog Box](#). This tab lets you specify a de-embedding distance. Just as in a wave port, de-embedding is an optional post processing step employed when the phase of the S-parameter elements is of interest. The interface for de-embedding a Floquet port is the same as that for a wave port. For this example, we omit specifying any de-embedding.

Floquet Port: 3D Refinement

See [Floquet Port: 3 D Refinement Dialog Box](#). The 3D Refinement tab controls which Floquet modes participate in 3D adaptive mesh generation.

The default settings are such that Floquet modes will not participate in 3D adaptive refinement.

In any model with wave, lumped, or Floquet ports, there is a 3D modal field pattern associated with each defined mode. This is the 3D field pattern corresponding to stimulation of the one mode, with all other modes terminated with a matched impedance. The 3D mesh that is created by HFSS on subsequent adaptive passes is actually a compromise designed to adequately represent all modal field patterns simultaneously.

When a specific modal field pattern is of interest, greater solution efficiency is achieved by adapting only on the basis of the one field pattern. In the case at hand, the modal pattern corresponding to excitation of the Wave port is of prime interest. Hence, the default setting of the 3D refinement tab ignores the Floquet modal field patterns with regard to adapting the 3D mesh.

Add Solution Setup

Add a solution setup for your model, as follows:

1. On the **Simulation** ribbon tab, click  **Setup > Advanced**.
The *Driven Solution Setup* dialog box appears.
2. Specify the settings as shown in the following figure:

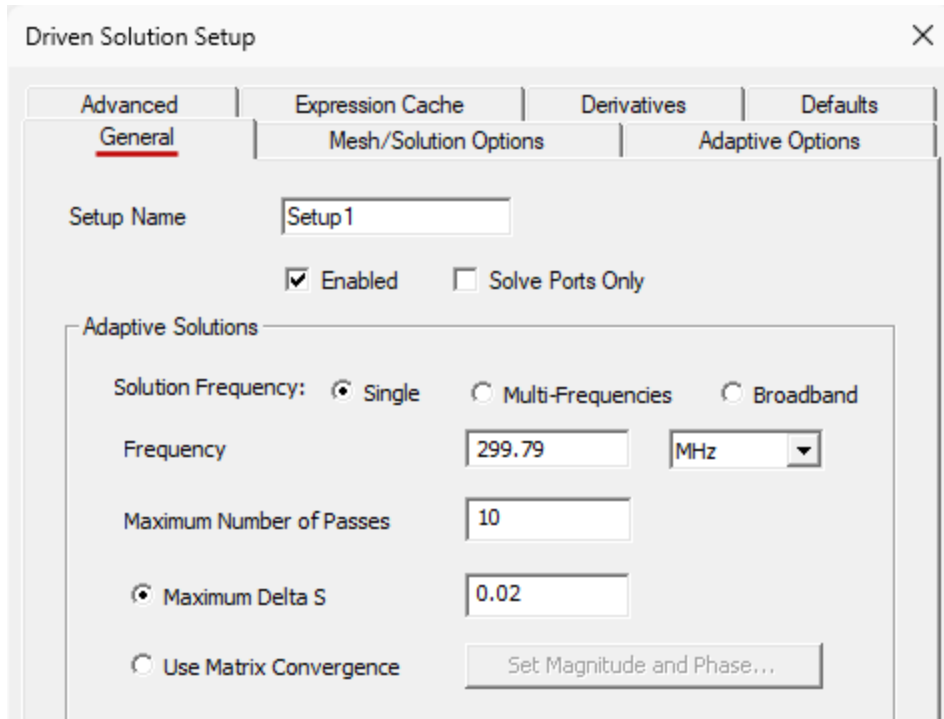

Figure 2-27: Driven Solution Setup – General Tab

3. Select the **Adaptive Options** tab.
4. Enter the settings as shown in the following figure:

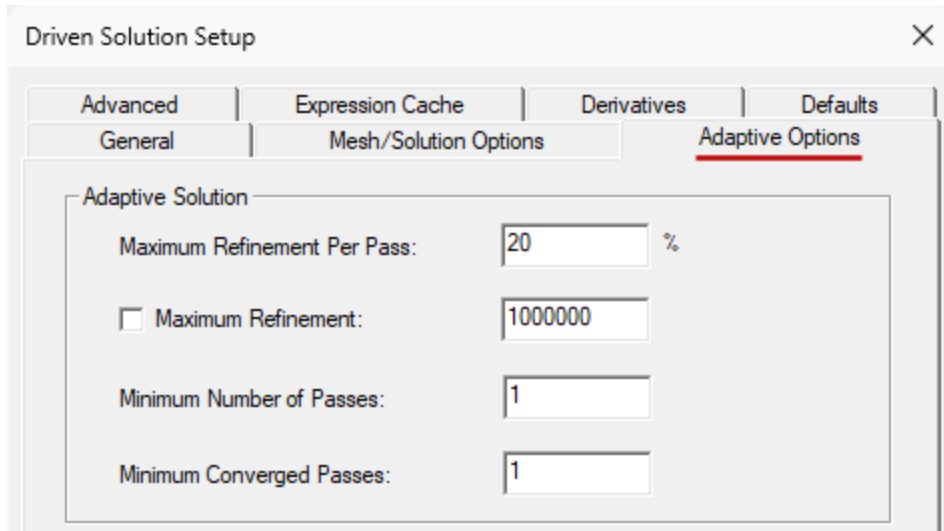

Figure 2-28: Driven Solution Setup – Adaptive Options Tab

5. Click **OK** to accept the settings.

The *Edit Frequency Sweep* dialog box appears automatically when you complete the solution setup for a model that already has at least one port assigned. However, for this exercise, no frequency sweep is needed.

6. Click **Cancel** to dismiss the dialog box without defining a sweep.

Run Simulation and View Results

Now that you have completed the entire set-up you are ready to analyze it. Before that, be sure to save the project.

1. On the **Simulation** ribbon tab, click  **Analyze All**.

The Progress Window indicates that HFSS is running the simulations. The Message Manager indicates normal completion of the simulation if everything went well.

2. Under *Analysis* in the Project Manager, right-click **Setup1** and select **Matrix Data**.

The *Solutions* dialog box appears with the *Matrix Data* tab selected.

Since phase is unimportant for this case, you can show the magnitudes only.

3. Select the **Format** subtab and choose **Magnitude** from the drop-down menu to simplify the matrix data table. Then, return to the **View** subtab:

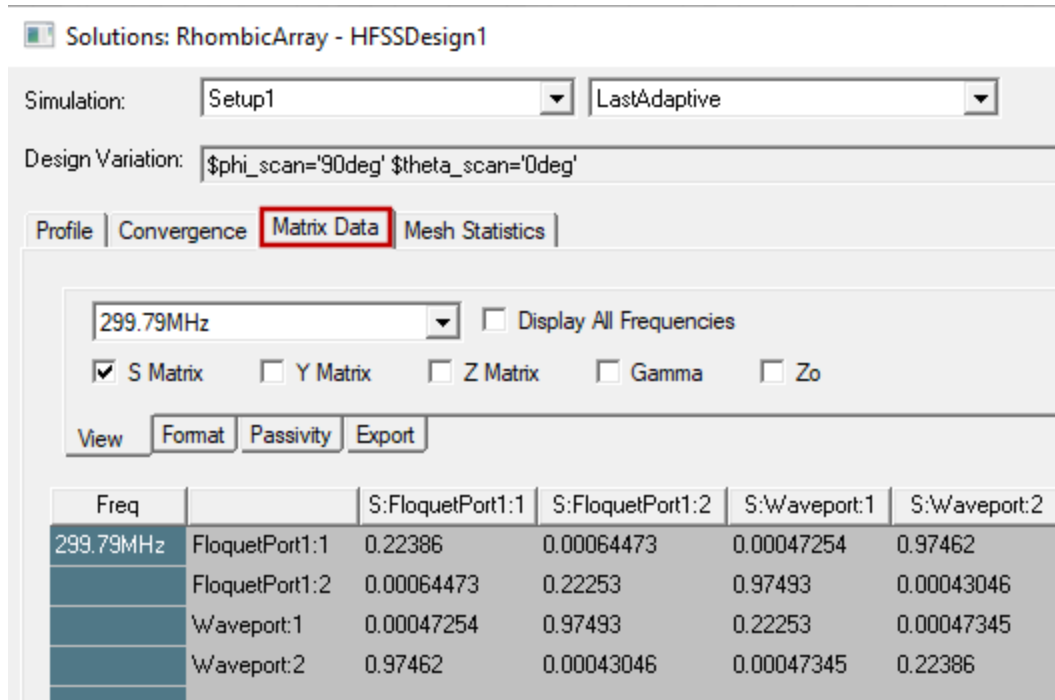

Figure 2-29: Solutions Dialog Box – Matrix Data Tab – Magnitudes Only

There are several things to note:

- The S-matrix is a 4×4 matrix and interrelates the wave port modes with the Floquet modes.
- The Floquet modes in the S-matrix are listed in the order specified in the Floquet port's Mode Setup panel. You can refer to this panel while the matrix data is displayed by double-clicking **FloquetPort1** in the Project Manager and selecting the **Modes Setup** tab. By doing so, you are reminded that FloquetPort1:1 refers to mode TE_{00} and FloquetPort1:2 refers to mode TM_{00} .
- The first and second columns of the S-matrix indicate the coupling of each individual Floquet mode excitation to the other ports and modes of the model. The physical picture of an excited Floquet mode is a plane wave incident on the infinite array from above. For this simulation, each Floquet mode transfers most of its power (over the Floquet port surface area) to the wave port mode with the same polarization. In these cases think of the array acting in “receive mode.”
- The third column of the matrix gives the modal amplitudes for a unit stimulation of the first mode of the Wave port (that is, the array acting in “transmit mode”). The third entry is the magnitude of the active reflection coefficient of the unit cell. The first and second rows give the power coupled into each of the two Floquet modes. Virtually all the non-reflected power is coupled into the first Floquet mode, which represents a plane wave leaving the face of the array. Similarly, the fourth column con-

tains the power transmitted to the Floquet modes in the first two rows, with the predominant amount going to the second Floquet mode.

4. **Close** the *Solutions* dialog box.

Create Variables for Scan Angles

Array antennas have the unique ability to redirect (scan) their energy without mechanical motion. To include the effects of scanning in the HFSS simulation, this section discusses parameterizing the simulation using scan angles.

1. On the menu bar, click **Project > Project Variables**.

The *Properties* dialog box appears.

2. In the **Project Variables** tab, click **Add**.

The *Add Property* dialog box appears.

3. Specify **\$phi_scan** for the **Name** and specify **90deg** for the **Value**:

The screenshot shows the 'Add Property' dialog box with the following fields:

- Name:** \$phi_scan
- Unit Type:** None
- Value:** 90deg
- Variable:** Selected (radio button)

Figure 2-30: Add Property Dialog Box

4. Click **OK**.

The *Add Property* dialog box closes and the variable *\$phi_scan* has been added to the *Project Variables* tab of the *Properties* window.

5. Click the **Add** button again.
6. In the *Add Property* dialog box, specify **\$theta_scan** for the **Name** and **0deg** for the **Value**.
7. Click **OK**.

The *Add Property* dialog box closes and the variable *\$theta_scan* has been added to the *Project Variables* tab of the *Properties* window:

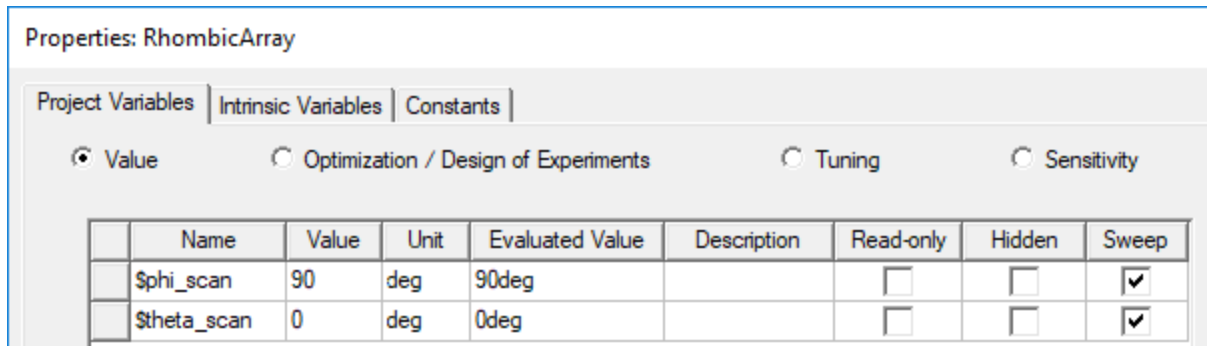

Figure 2-31: Properties Dialog Box – Project Variables Tab

- Click **OK**.
- It's a good time to  **Save** your model.

Note:

When using scan angles in unit cell models, the plane of periodicity (here, the array plane) should be parallel to the global x-y plane. Adhering to this natural convention ensures the simplest and clearest relationship between scan angles and the structure being modeled.

Use Scan Angles for the Model

Now that you created the scan angle variables, you will use them in the model. To do so, perform the following steps:

- Under *Boundaries* in the Project Manager, double-click **Secondary1**.

The *Secondary* dialog box appears.

- Select the **Phase Delay** tab and specify the **Phi** and **Theta Scan Angles** as shown in following figure:

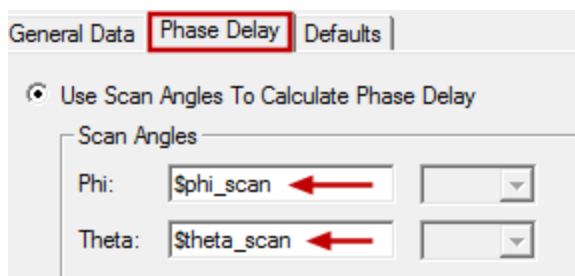

Figure 2-32: Using Scan Angles Variables

3. Click **OK**.

The scan angles are set for *Secondary1* and also copied into the settings for *Secondary2*.

Note:

Ignore the following informational message that will appear in the Message Manager window: “*Solutions have been invalidated. Undo to recover.*”

Set Up Parametric Sweep of Scan Angle

To illustrate more aspects of the Floquet port interface, we now seek the active reflection coefficient of the array as a function of scan angle. When the scan direction is in the E-plane of the array, the array exhibits a nice example of scan blindness at an angle of 27.5 degrees. To demonstrate this and other phenomena, we will set up a parametric sweep to make an E-plane scan from broadside (scan = 0) to endfire (scan = 90 degrees).

To setup a parametric analysis:

1. On the **Simulation** ribbon tab, select **Parametric** from the **Optimetrics** drop-down menu:

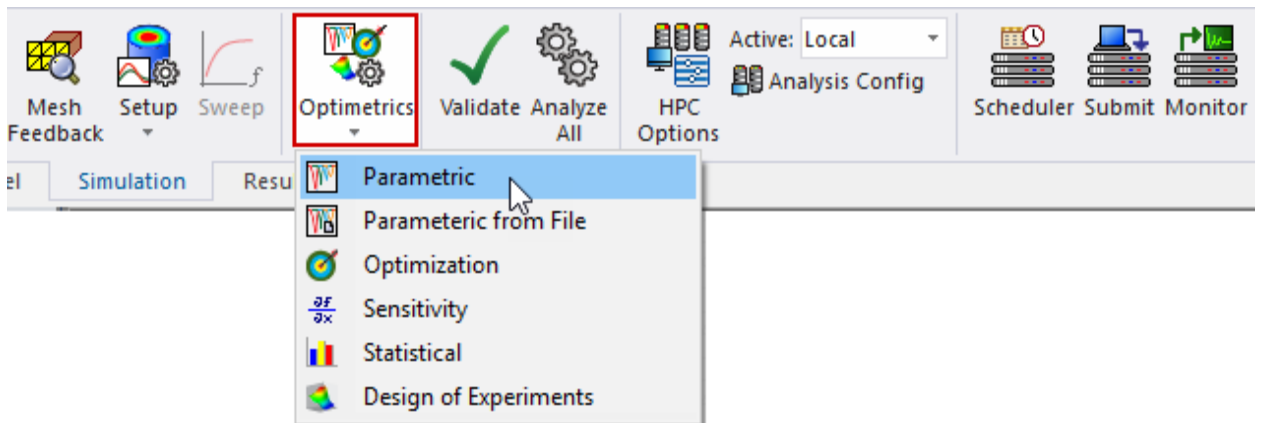
**Figure 2-33: Optimetrics Drop-Down Menu – Parametric Command**

The *Setup Sweep Analysis* dialog box appears.

2. On the **Sweep Definitions** tab, click **Add**.

The *Add/Edit Sweep* dialog box appears.

- Specify the sweep settings as shown in the left half of the following figure:

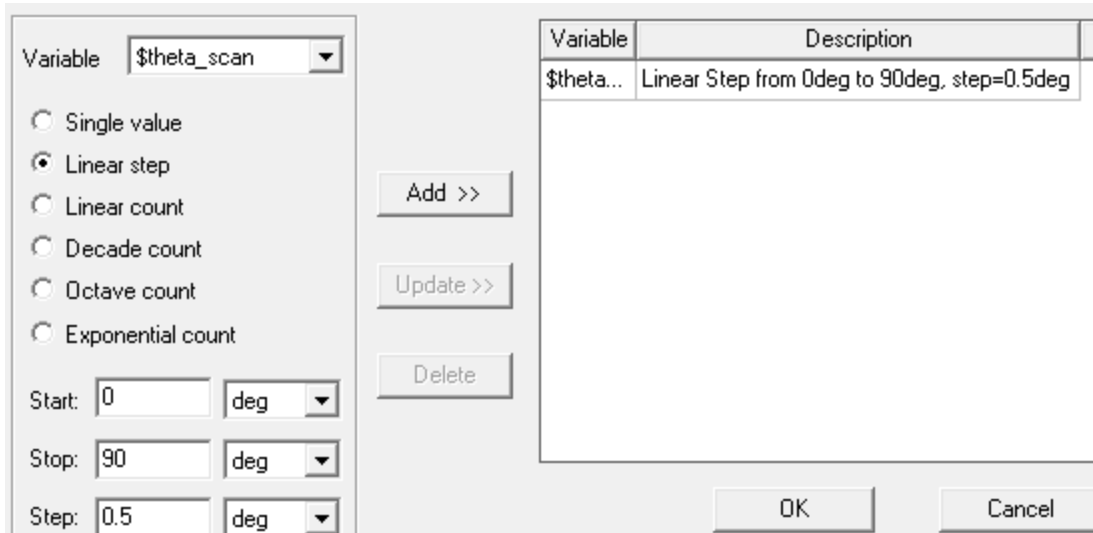

Figure 2-34: Add/Edit Sweep Dialog Box

- Click **Add >>** to include the variable and its settings in the list on the right half of the dialog box.
- Click **OK**.

The *Setup Sweep Analysis* dialog box now lists the *\$theta_scan* variable and its description.

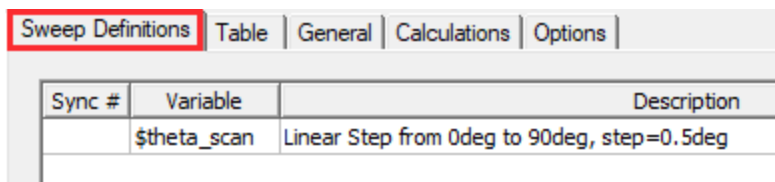

Figure 2-35: \$theta_scan Variable Added to Sweep Analysis Setup

- Click **General** to verify the settings are as in following figure:

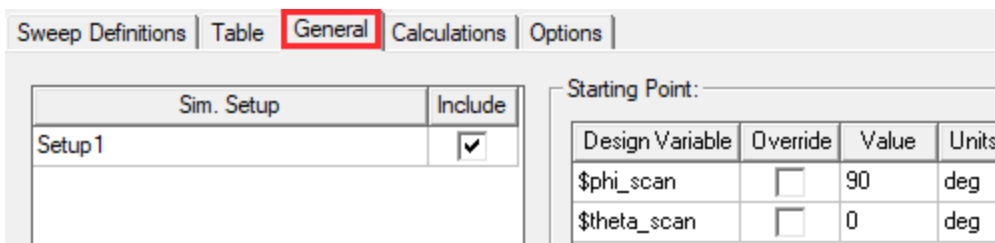

Figure 2-36: Setup Sweep Analysis Dialog Box – General Tab

- Select the **Options** tab and ensure the settings are as shown in the following figure:

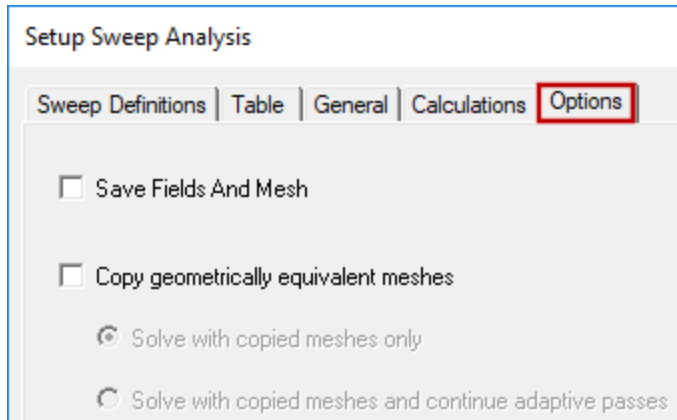

Figure 2-37: Setup Sweep Analysis Dialog Box – Options Tab

8. Click **OK** to accept the setup and close the dialog box.

Parametric Setup1 is now listed under *Optimetrics* in the Project Manager.

Set Up Modes for Parametric Sweep

1. Double-click **FloquetPort1** under *Excitations* in the Project Manager.

The *Floquet Port* dialog box appears.

2. Select the **Modes Setup** tab.

Note:

A pair of modes is adequate for a broadside scan. For larger scan angles, additional modes are required.

3. Click **Modes Calculator**.

Note:

The inputs for mode selection do not affect the model set up. Therefore, you can vary the choices to explore different scenarios.

4. Make the following changes to the settings:

a. **Number of Modes = 10**

Note:

Requesting so many modes will give you an idea which modes are necessary and which are not.

b. **Frequency = 299.97 MHz**, which is the actual frequency of the simulation.

Note:

If the problem setup contains more than one frequency sweep, this value is usually set to the highest frequency to detect higher-order propagating modes.

c. *Scan Angles: Phi*

- **Start = 90 deg**
- **Stop = 90 deg**
- **Step Size = 0 deg**

d. *Scan Angles: Theta*

- **Start = 0 deg**
- **Stop = 90 deg**
- **Step Size = 0.5 deg**

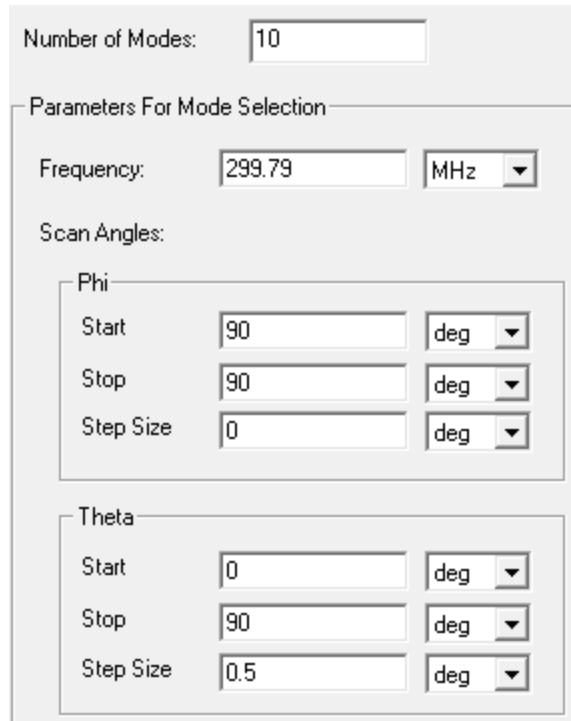

The dialog box is titled "Mode Table Calculator". It features a "Number of Modes" input field set to "10". Below this is a section titled "Parameters For Mode Selection". Under this section, there is a "Frequency" input field set to "299.79" and a unit dropdown menu set to "MHz". Below the frequency is a "Scan Angles" section. This section contains two sub-sections: "Phi" and "Theta". The "Phi" section has three input fields: "Start" (90), "Stop" (90), and "Step Size" (0), each with a unit dropdown menu set to "deg". The "Theta" section also has three input fields: "Start" (0), "Stop" (90), and "Step Size" (0.5), each with a unit dropdown menu set to "deg".

Figure 2-38: Mode Table Calculator Dialog Box

Note:

To create a set of modes that will be adequate for every scan direction in the parametric sweep, the scan angles of the sweep are entered in a start-stop-step format. The entered angles are spherical polar angles of the global coordinate system.

5. Click **OK**.

The calculator closes and displays the results in the modes table:

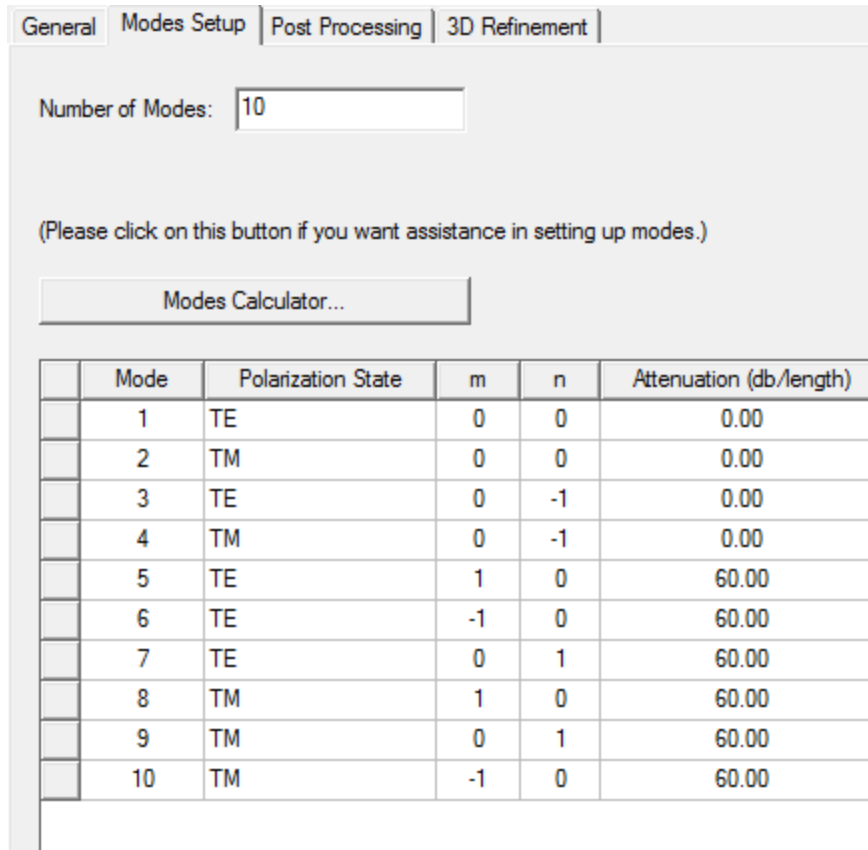

Figure 2-39: Floquet Port Dialog Box – Modes Setup Tab

6. Reduce the value for the **Number of Modes** from 10 to 4.

The table gets trimmed to only 4 modes. The reason for trimming the modes is discussed in the next topic ([Mode Selection](#)).

7. Click **OK**.
8. Right-click **ParametricSetup1** under *Optimetrics* in the Project Manager and select **Analyze**.

HFSS runs the Parametric Sweep.

Note:

The parametric analysis will take some time to solve.

Mode Selection

In the previous topic, you set up modes using the *Modes Calculator*. This topic describes the modes table and the criteria for mode selection. The attenuation (db/length) depends on the

scan angle you set in the *Modes Calculator*.

Refer to the figure, [Floquet Port Dialog Box – Modes Setup Tab](#), and note the following details about the results:

- The original pair of specular modes, TE_{00} and TM_{00} remain at the top of the list.
- The attenuation for both TE_{00} and TM_{00} is 0 dB, meaning that these modes are propagating unattenuated in at least one scan direction among those selected in the [Mode Table Calculator](#).
- A second pair of modes, TE_{0-1} and TM_{0-1} are also propagating unattenuated in at least one scan direction.
- The six remaining modes experience attenuation of 60 dB per meter (the current default length unit) over the set of specified scan directions.
- Any Floquet modes generated within the 3D portion of the model and propagating toward the Floquet port must be accounted for in the modes table. Since the first four listed modes reach the Floquet port unattenuated, we have retained them.
- The remaining modes, with large non-zero attenuation, can be excluded from the table. Eliminating unnecessary modes increases simulation efficiency and eases interpretation of results. The next point provides a quantitative justification for the omission of the modes with large non-zero attenuation.
- Because the length of the unit cell is 1.25 meters, any of the last six modes that are generated at the rectangular aperture experience a minimum attenuation of $1.25 * 60\text{dB} = 75\text{ dB}$ by the time they reach the Floquet port plane. In most simulations this is small enough for you to neglect such modes. Hence, we have the shortened table on which the parametric solution was based:

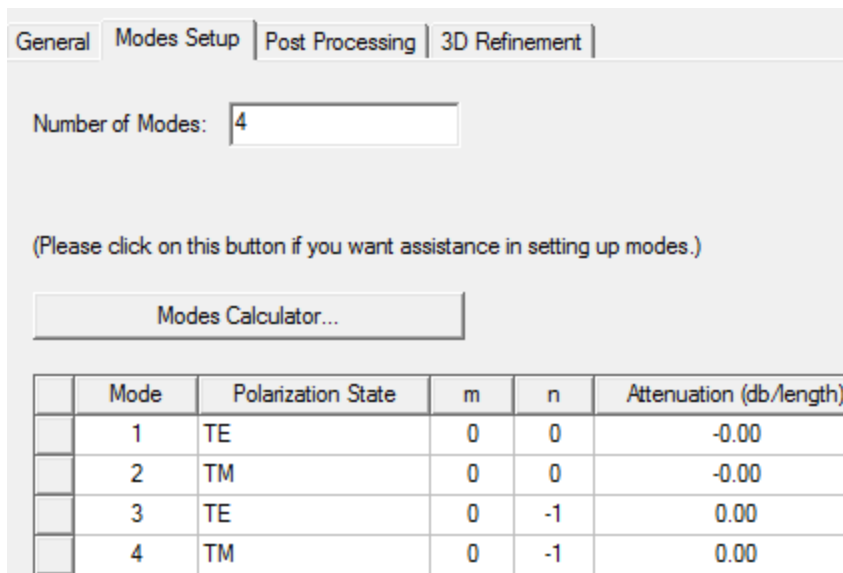

General Modes Setup Post Processing 3D Refinement

Number of Modes:

(Please click on this button if you want assistance in setting up modes.)

Modes Calculator...

	Mode	Polarization State	m	n	Attenuation (db/length)
	1	TE	0	0	-0.00
	2	TM	0	0	-0.00
	3	TE	0	-1	0.00
	4	TM	0	-1	0.00

Figure 2-40: Selected Modes for Parametric Analysis

The modes list is trimmed from the bottom up, and now, only the TE_{00} , TM_{00} , TE_{0-1} , and TM_{0-1} remain.

Note:

You can again increase the modes by entering a number greater than 4, and the additional modes will reappear in the list. However, the correct *Attenuation* values will not be shown unless you return to the *Modes Calculator* and click **OK** to refresh the calculations. Remember to use the minimum acceptable number of modes to ensure simulation efficiency.

View Parametric Sweep Results

Once the simulation is over, the S-matrix coefficients at various scan angles can be examined in the **Matrix Data** tab of the *Solutions* dialog box or by creating a report (plot). Let's take a look at the matrix data first.

Review Matrix Data:

1. Under *Analysis* in the Project Manager, right-click **Setup1** and choose **Matrix Data** from the shortcut menu.
2. Select the **Format** subtab and ensure that **Magnitude** is still selected in the drop-down menu as the specified format. Then, return to the **View** subtab.
3. Click the **ellipsis** button (...) to the right of the *Design Variation* description.

The *Set Design Variation* dialog box appears.

4. From the *\$theta_scan* list, select **15deg** and click **OK**.

Your matrix data should be similar to the following figure:

Simulation: Setup1 LastAdaptive

Design Variation: $\phi_{scan}='90deg'$ $\theta_{scan}='15deg'$

Profile | Convergence | **Matrix Data** | Mesh Statistics

299.79MHz Display All Frequencies

S Matrix Y Matrix Z Matrix Gamma Zo

View | Format | Passivity | Export

Freq		S:FloquetPort1:1	S:FloquetPort1:2	S:FloquetPort1:3	S:FloquetPort1:4	S:Waveport:1	S:Waveport:2
299.79MHz	FloquetPort1:1	0.2031	0.00061133	0.00087265	6.5301e-05	0.0013807	0.97916
	FloquetPort1:2	0.0012567	0.12632	7.3277e-06	0.0008774	0.99199	0.0011722
	FloquetPort1:3	0.00073166	5.4712e-05	0.0031398	0.00012528	1.338e-05	0.00089886
	FloquetPort1:4	9.6127e-05	0.0010503	0.00012525	0.00021718	0.0009609	8.2287e-05
	Waveport:1	0.00061931	0.99199	5.5748e-05	0.001121	0.12632	0.00063328
	Waveport:2	0.97916	0.00044295	0.00076273	0.00010852	0.0011233	0.2031

Figure 2-41: Solutions Dialog Box – Matrix Data Tab ($\theta_{scan} = 15$ Deg)

- Repeat step 4 several times choosing different θ_{scan} values and observe the matrix coefficients at each different scan angle.

Observations:

The first four rows of the last two columns indicate the relative amount of coupling between the four Floquet port modes and the two wave port modes. For any particular scan angle, you may notice minimal coupling between a particular Floquet port mode and both of the wave port modes (indicated by very small S-matrix values). For example, at $\theta_{scan} = 15$ deg, the coupling is minimal at the third and fourth Floquet modes (TE_{0-1} and TM_{0-1}). However, if you sample the results at several different scan angles, you will see that all four Floquet modes produce significant wave port coupling at some part of the scan angle range. If you had retained any of the additional six modes that were calculated but later removed, you'd see minimal coupling across the entire scan angle range, due to the calculated 60 db/meter attenuation of the higher modes.

- Close the Solutions dialog box.

Generate Plots:

This section describes how to generate reflection and transmission plots. Follow the procedure below to create a report showing the active reflection $[S(\text{Waveport}:1, \text{Waveport}:1)]$ and transmission magnitudes for the second and fourth Floquet modes (TM_{01} and TM_{0-1}) plotted as a function of the scan angle:

- On the **Results** ribbon tab, access the  **Modal Solution Data Report** drop-down

menu and click  **2D**.

The *Report* dialog box appears.

- Specify the settings as shown in following figure:

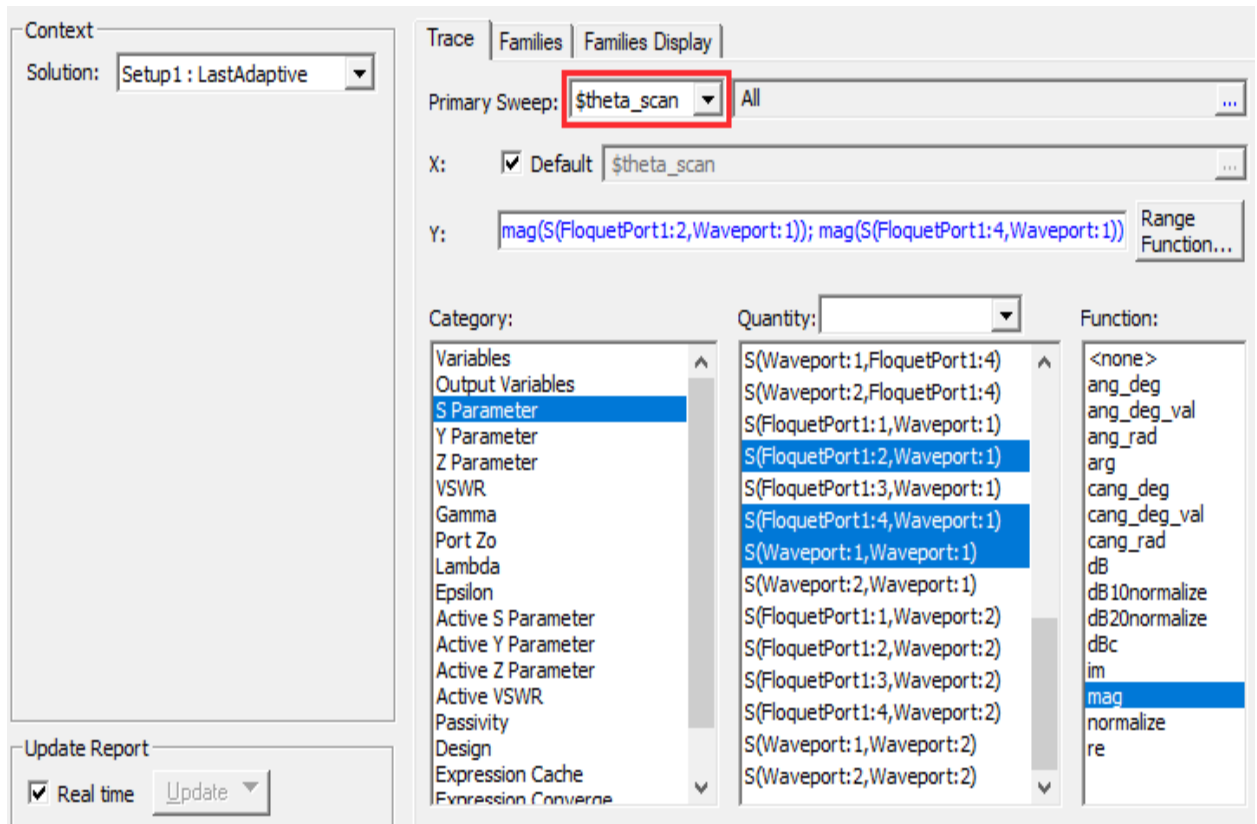

Figure 2-42: Report Dialog Box

- Click **New Report** and click **Close**.

S Parameter Plot 1 is displayed, which should resemble the following figure:

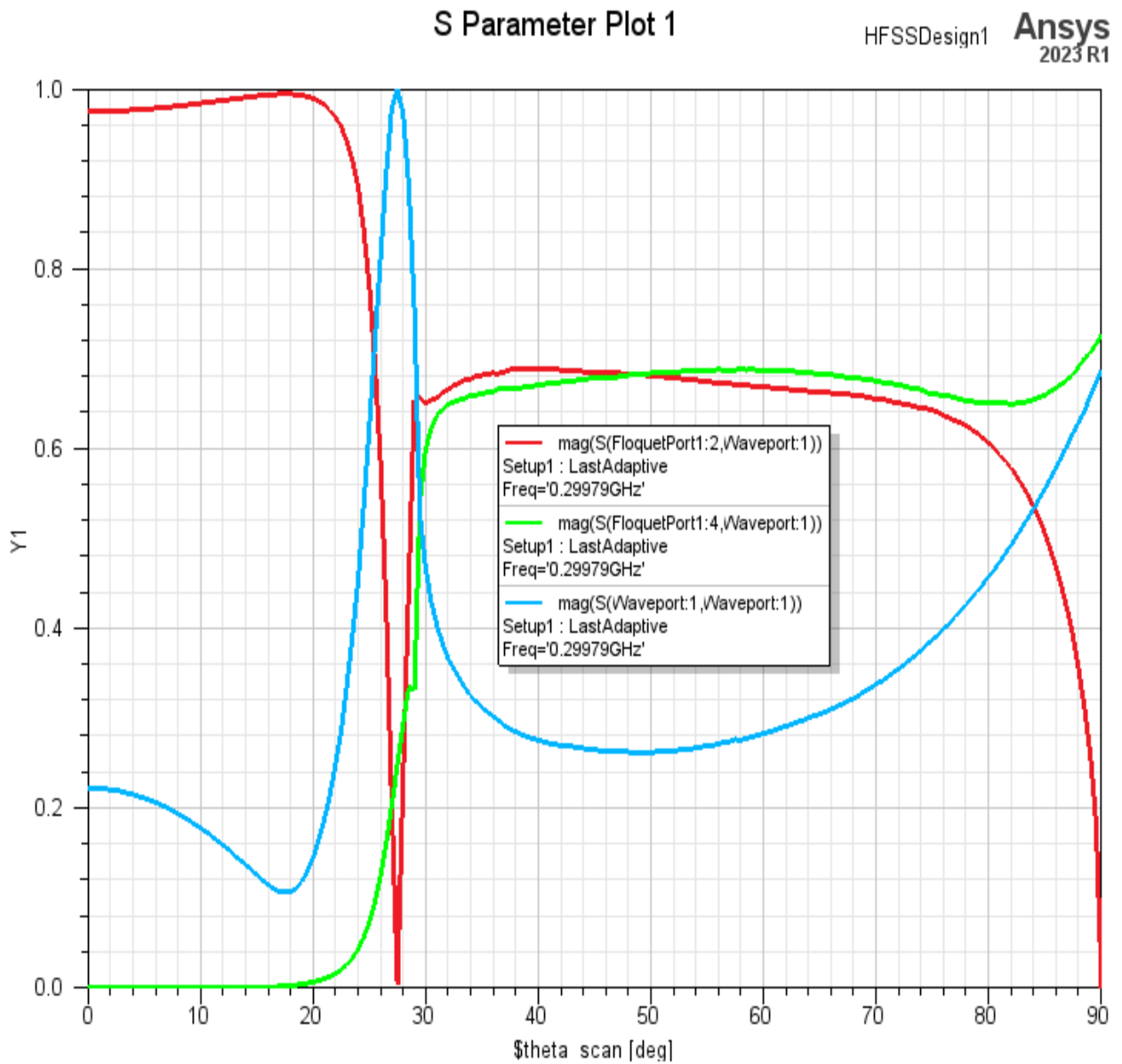

Figure 2-43: S Parameter Plot 1 – Reflection and Transmission Magnitudes

Observations:

The active reflection coefficient (blue trace) shows the scan blindness condition at 27.5 degrees. Also, note that the TM_{0-1} mode (green trace) becomes propagating at about 30 degrees and represents the onset of a grating lobe. From 30 to 80 degrees, power is about equally split between the TM_{00} (red trace) and TM_{0-1} modes, after which the endfire condition is approached.

3 - Frequency Selective Surface Model

This chapter contains the following topics:

- Sample Project – FSS
- Set Unit and Solution Type
- Create the Rhombic Sheet
- Transform 2D Sheet into 3D Cell Object
- Position the Rhombus Appropriately
- Create the Aperture
- Move the Aperture to the Rhomboid
- Assign Primary and Secondary Boundaries
- Assign the Perfect E-Boundary
- Assign the Floquet Ports
- Set Up the Analysis
- Add Frequency Sweep and Analyze
- Run the Simulation
- Evaluate the Results
 - Phase Transmission vs. Frequency
 - S-Parameters vs. Frequency
 - Port Field Display for Modes

Sample Project – FSS

You can construct unit cells for frequency selective surface (FSS) simulations using linked boundaries and two Floquet ports, with one port above the plane of the structure and the other port under it. The applied excitations are the Floquet modes themselves, usually one or both specular modes. As a direct result of the field solution, the reflection and transmission properties of the FSS are cast in terms of the computed S-matrix entries interrelating the Floquet modes.

This is somewhat in contrast to the simulation setup when PMLs or radiation boundaries are used to terminate the unit cell. In these cases, in addition to the boundary setup, one or more incident waves are defined separately as the excitation. The transmission and reflection properties of the FSS are then automatically computed for the user as a post-processing operation on the field solution.

We will consider a conducting screen containing a rhombic lattice of circular apertures. The lattice geometry is shown below, in which a pair of lattice vectors are drawn in blue. The angle between the lattice vectors is 60 degrees.

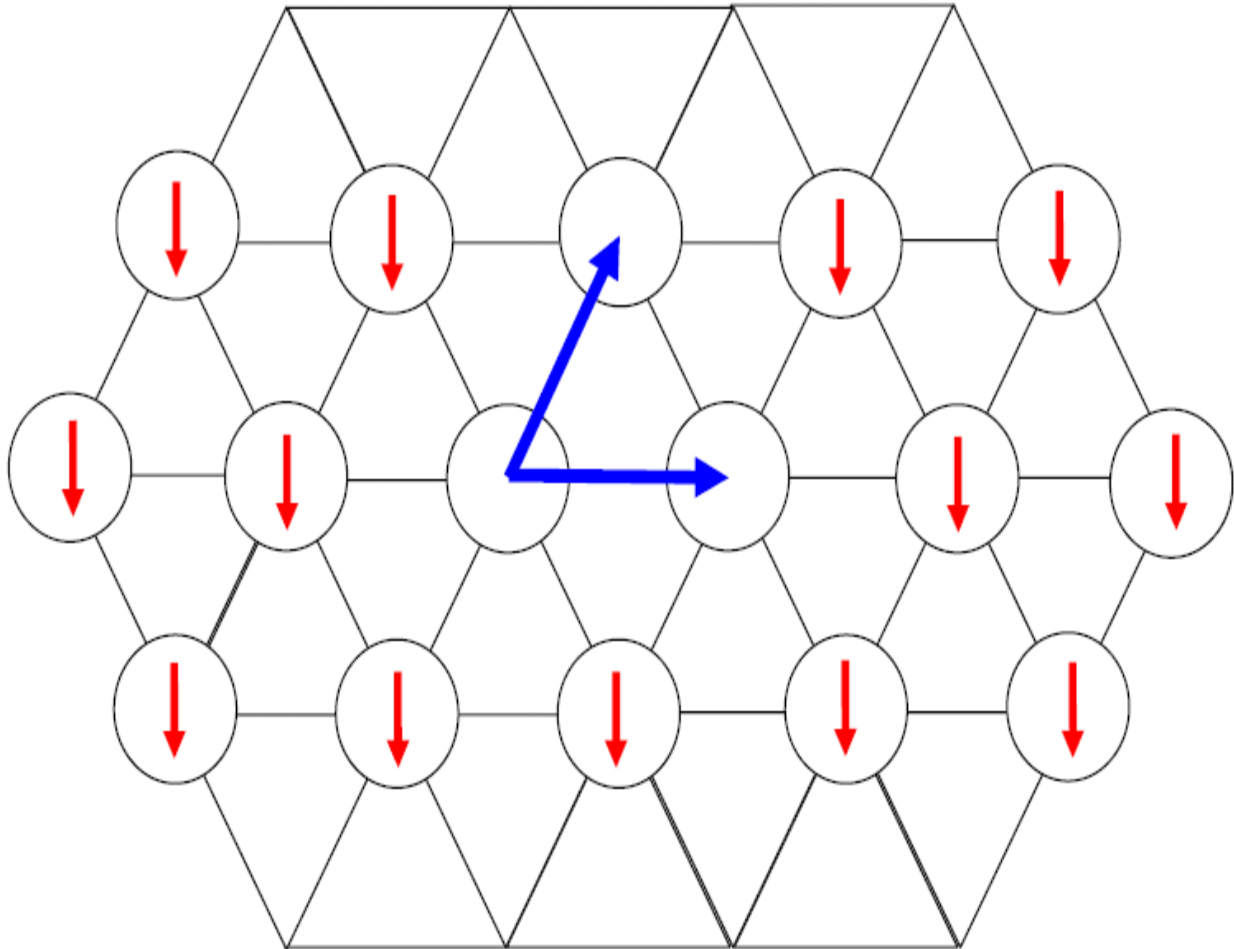

Figure 3-1: The Lattice Geometry

Consider a plane wave incident normal to the screen with polarization aligned as indicated by the red arrows in the figure. The transmission loss magnitude and phase, as a function of frequency, are the quantities of interest. The frequency band is 8 to 20 GHz.

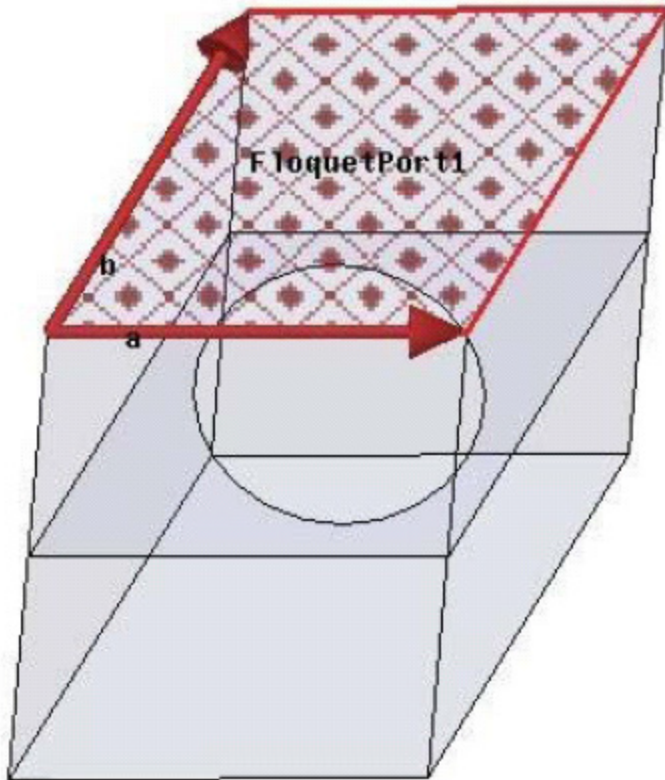



Figure 3-2: Unit Cell for Rhombic Lattice

Set Units, Options, and Solution Type

Define the name, options, design type, units, and solution type for this project before you build the model.

1. Launch *Ansys Electronics Desktop* and name a new project **RhombicLatticeFSS** (by renaming *Projectx* at the top of the Project Manager).
2. On the **Desktop** ribbon tab, click  **General Options**.
 - a. In the tree on the left side of the *Options* dialog box, select the **3D Modeler > Drawing** group.
 - b. Deselect the **Edit properties of new primitives** option.

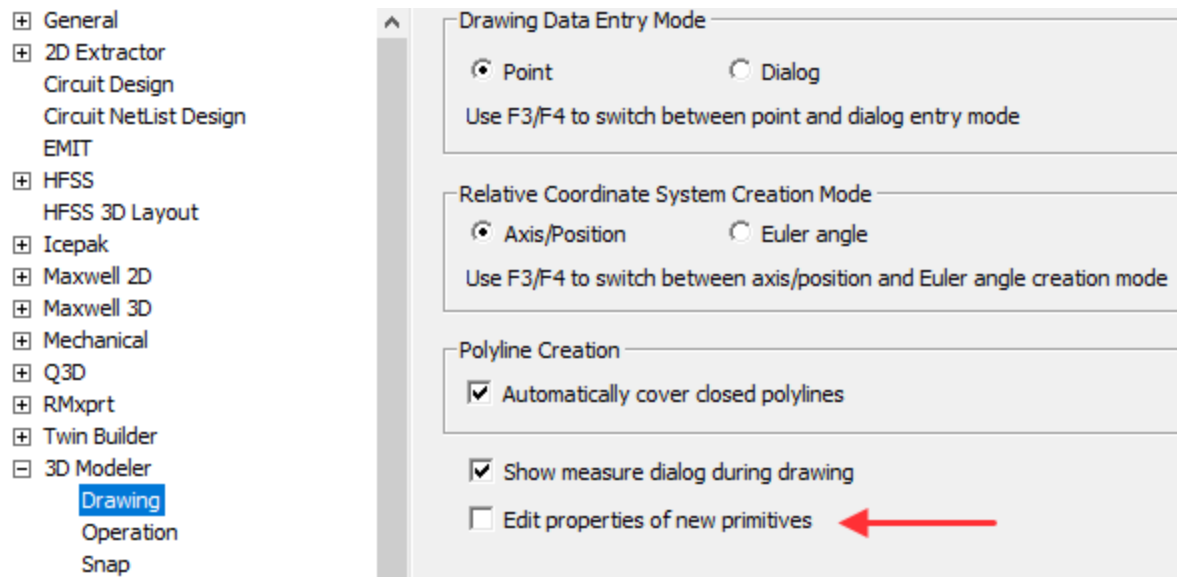



Figure 3-3: Options Dialog Box – 3D Modeler > Drawing Group

Note:

In other HFSS getting started guides, this option has been enabled, and you've used the pop-up *Properties* dialog box to edit the parameters of newly drawn objects. For this exercise, the *Properties* dialog box will **not** appear when you draw a new object. Instead, you will use the *docked Properties window* (located beneath the Project Manager by default) to edit the properties of new objects.

3. On the **Desktop** ribbon tab, click  **Insert HFSS design**. (You do not have to access the drop-down menu. the default menu action is to insert a conventional HFSS design.)
4. On the **Draw** ribbon tab, click **Units**, choose **cm** from the **Select Units** drop-down menu, and click **OK**.
5. From the menu bar, click **HFSS > Solution Type**.

The *Solution Type* dialog box appears.

6. Under *Options*, select **Modal** and also ensure that the remaining settings are as shown in the following image:

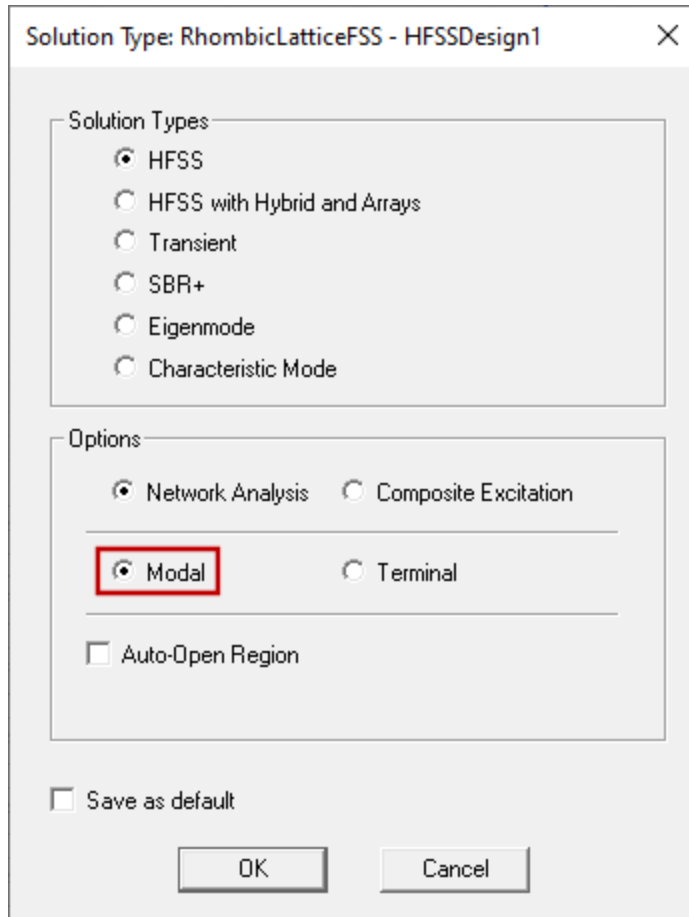

Figure 3-4: Solution Type Dialog Box

7. Click **OK**.

If you skipped the *Array Antenna* chapter and intend to proceed directly to the *Frequency Selective Surface Model*, then complete the following procedure, which was covered in the earlier chapter. Then proceed to the next topic:

- [Enable Legacy View Orientations](#)

Create the Rhombic Sheet

You will create a simple unit cell model, as shown in the figure, [Unit Cell for Rhombic Lattice](#). All four sides are the same length (1.73 cm each), the circular aperture diameter is 1.2 cm, and the cell is 4 cm high. The obtuse angles are 120 degrees each, and the acute angles are 60 degrees each. The unit cell clearly is a rhombus. You will begin by creating a rhombic sheet object, as follows:

1. On the **Draw** ribbon tab, click  **Draw line** and press **F3** to ensure that you are using the graphical drawing mode.

2. In the Modeler window, click an arbitrary starting point and then, click *three* more arbitrary points.
3. Click on the *starting point* to create a closed object.
4. Right-click in the Modeler window and select **Done** from the short-cut menu to complete creation of an initial polyline object.

In the History Tree, you should see four *CreateLine* segments under *Model > Lines > Polyline1 > CreatePolyline*:

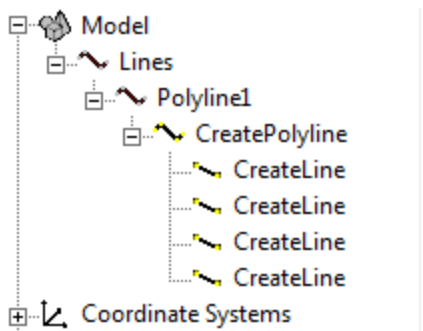

Figure 3-5: History Tree after Creating Polyline1

5. In the History Tree, select the first **CreateLine** segment.

The line segment's properties appear in the docked *Properties* window beneath the Project Manager.

6. Edit the coordinates in the **Point1** and **Point2 Value** column to agree with the following figure:

	Name	Value	Unit	Evaluated Value
	Segment Type	Line		
	Point1	0 , 0 , 0	cm	0cm , 0cm , 0cm
	Point2	0.865 , 1.4982 , 0	cm	0.865cm , 1.4982cm , 0cm

Figure 3-6: Polyline Properties – First CreateLine Segment

Press **Enter** to accept each set of endpoint coordinates.

7. Repeat steps 5 and 6 for the second and third *CreateLine* segments, specifying the coordinates from the following images:

	Name	Value	Unit	Evaluated Value
	Segment Type	Line		
	Point1	0.865 , 1.4982 , 0	cm	0.865cm , 1.4982cm , 0cm
	Point2	2.595 , 1.4982 , 0	cm	2.595cm , 1.4982cm , 0cm

Figure 3-7: Polyline Properties – Second CreateLine Segment

Name	Value	Unit	Evaluated Value
Segment Type	Line		
Point1	2.595 ,1.4982 ,0	cm	2.595cm , 1.4982cm , 0cm
Point2	1.73 ,0 ,0	cm	1.73cm , 0cm , 0cm

Figure 3-8: Polyline Properties – Third CreateLine Segment

Note:

For each subsequent segment, you only need to edit the coordinates of *Point2* because *Point2* of the previous segment is also *Point1* of the current segment. You do not need to edit either point for the last segment because its *Point2* is the same as *Point1* of the first segment (since this is a closed polyline object).

- Select the last CreateLine segment in the History Tree and verify that the coordinates match the following figure:

Name	Value	Unit	Evaluated Value
Segment Type	Line		
Point1	1.73 ,0 ,0	cm	1.73cm , 0cm , 0cm
Point2	0 ,0 ,0	cm	0cm , 0cm , 0cm

Figure 3-9: Polyline Properties – Fourth CreateLine Segment

- Click in the Modeler window's background to clear the current selection and press **Ctrl+D** to fit the view.

Your rhombic sheet object should look like the following figure:

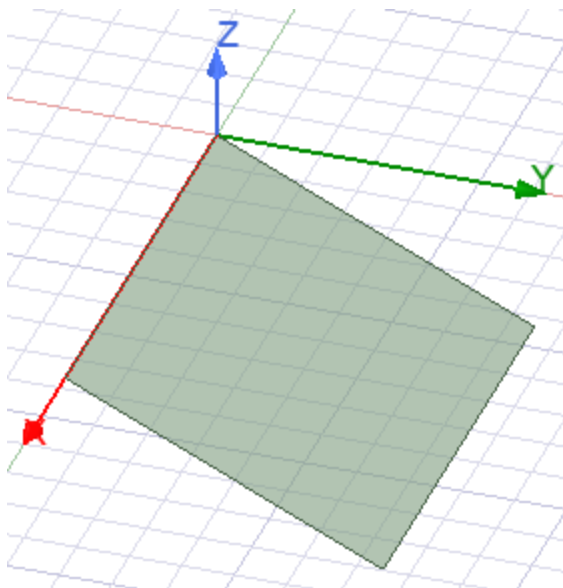

Figure 3-10: Rhombic Sheet Created

Transform 2-D Sheet into a 3D Cell Object

Before sweeping the 2D sheet into a 3D object, place a copy of it on your system clipboard to facilitate creating the aperture object in the next procedure. Avoid using the copy and paste feature until you've pasted a copy of the sheet object into your design, so that the contents of the clipboard won't be overwritten.

After copying the 2D sheet object (*Polyline1*) to the clipboard, you will sweep it along a global Z direction vector to produce your 3D cell object.

1. Under *Model > Sheets > Unassigned* in the History Tree, click **Polyline1** to select it.
2. Press **Ctrl+C** to copy the selected sheet object to your system clipboard.

Attention: Avoid using the copy or paste feature again until you're ready to paste a copy of the sheet object into your design, so that the contents of the clipboard won't be accidentally overwritten. You will complete the pasting operation as part of the [Create the Aperture](#) procedure, which immediately follows this procedure.

3. On the **Draw** ribbon tab, click  **Sweep Along Vector**.
4. Click the global origin (snap point) to set the first point of the sweep vector.
5. Input the second point of the sweep vector using the coordinate text boxes in the status bar, as follows:
 - **dx = 0**
 - **dy = 0**
 - **dz = 4**

The *Sweep Along Vector* dialog box appears.

6. Select **Natural** from the **Draft type** drop-down menu, verify that the **Draft angle = 0**, and then click **OK**.

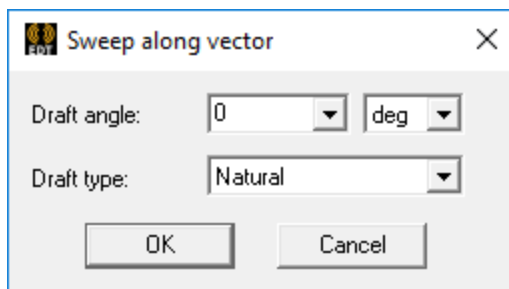

Figure 3-11: Sweep Along Vector Dialog Box

The properties of the 3D object are displayed in the docked *Properties* window.

7. In the **Attribute** tab of the docked *Properties* window, make the following changes:

- a. Change the **Name** from *Polyline1* to **RhombicCell**.
 - b. Ensure that **Material Appearance** is **not** selected.
 - c. Set the **Transparent** value at **0.6**.
8. Select the **Command** tab of the docked *Properties* window and verify that your sweep settings match those shown in the following figure:

Name	Value	Unit	Evaluated Value
Command	SweepAlongVector		
Coordinate System	Global		
Vector	0,0,4	cm	0cm, 0cm, 4cm
Draft angle	0	deg	0deg
Draft type	Natural		
Suppress Command	<input type="checkbox"/>		

Figure 3-12: SweepAlongVector Properties

9. Press **Ctrl+D** to fit the view.
10. Clear the current selection.

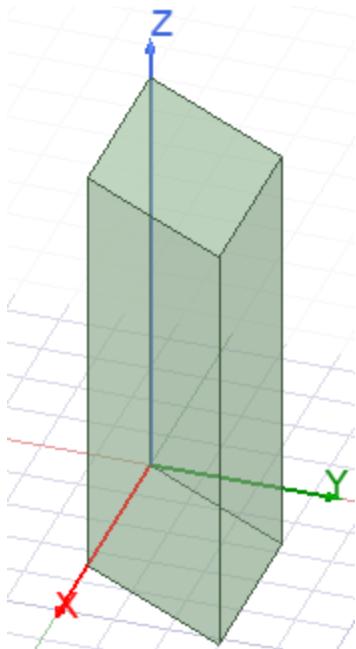

Figure 3-13: RhombicCell Created

Create the Aperture Object

In this procedure, you will paste a copy of the closed polyline sheet object that you copied to your system clipboard during the preceding [Transform 2D Sheet into a 3D Cell Object](#) procedure. It

will be pasted into the model at its original location, which is lying along the global XY plane. This places it initially at the bottom of the 3D cell.



Afterward, you will [Reposition the 3D Cell](#) so that its height is bisected by the global XY plane. That is, half of the cell height will be in the -Z half of the Cartesian coordinate system, and half will be in the +Z half. The 2D aperture object will remain at the XY plane (Z=0). Therefore, the aperture will be at the middle of the 3D cell's height after you accomplish the repositioning operation.

Perform the following steps to create the aperture:

1. Press **Ctrl+V** to paste the contents of your system clipboard into the model (previously copied rhombic 2D sheet object). Leave the pasted object selected.

Attention: If you've inadvertently cleared or overwritten your system clipboard, you will not be able to select, copy, and paste the original closed polyline object. *CreatePolyline*, in the History Tree, will no longer be recognized as a sheet object, and you will encounter an error message when trying to paste it. You can use the following alternative steps to produce the aperture sheet object.

Alternative Procedure:

- a. Press **F** to begin the *Face* selection mode.
 - b. Click near the **bottom** edge of one of the visible vertical faces of the *RhombicCell* object. The clicked side face is initially selected.
 - c. Press **B** to select the face *Behind* the clicked point. The bottom face should then be selected.
 - d. On the **Draw** ribbon tab, click  **Surface > Create Object from Face**.
- A sheet object duplicating the bottom face of the cell is added to the model.
2. In the **Attribute** tab of the docked *Properties* window, make the following changes:
 - a. Change the **Name** to **Aperture**.
 - b. Ensure that **Material Appearance** is **not** selected.
 - c. Change the **Color** to **brown** (column 2, row 5 of the color swatches; Red: 128, Green: 64, Blue: 0).
 - d. Set the **Transparent** value at **0**.
 3. On the **Draw** ribbon tab, click  **Draw circle**.
 4. Click the **center** of the *Aperture* sheet object (a solid circle indicates the snapping point at the shape centroid).
 5. Use the coordinate text boxes in the status bar to specify the radius of the circle, as follows, and then press **Enter**.
 - **dx = 0.6**
 - **dy = 0**
 - **dz = 0**

The circle's details are displayed in the docked *Properties* window.

- Verify that the properties within the **Command** tab of the docked *Properties* window match the following figure:

	Name	Value	Unit	Evaluated Value
	Command	CreateCircle		
	Coordinate Sys...	Global		
	Center Position	1.2975 ,0.7491 ,0	cm	1.2975cm , 0.74...
	Axis	Z		
	Radius	0.6	cm	0.6cm
	Number of Seg...	0		0

Figure 3-14: Circle Properties – Command Tab

- Clear the current selection.
- Under *Model > Sheets > Unassigned* in the History Tree, select **Aperture** and **Circle1** (in that specific order).
- On the **Draw** ribbon tab, click  **Subtract**.

The *Subtract* dialog box appears.

- Verify that Aperture is in the **Blank Parts** list and **Circle1** is under **ToolParts**.

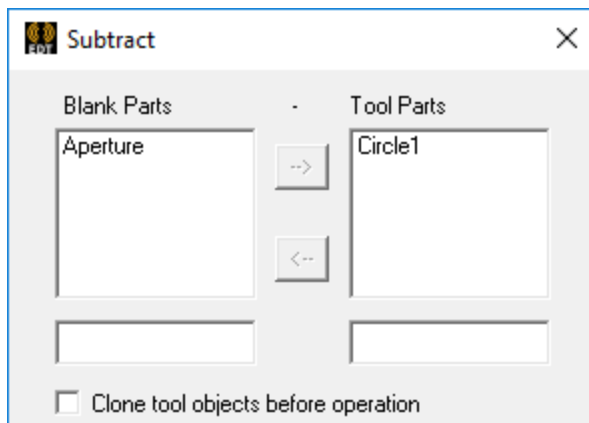

Figure 3-15: Subtract Dialog Box

- Click **OK** to perform the subtraction and close the dialog box.

The circle is subtracted from the rectangle to create the aperture:

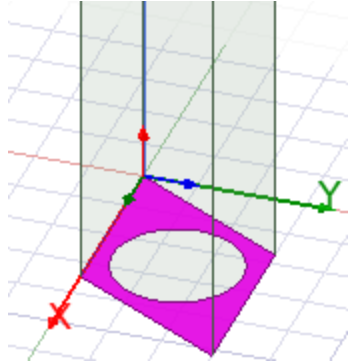



Figure 3-16: Aperture Completed

12. Clear the selection.

Reposition the 3D Cell

1. Under *Model* > *Solids* > *vacuum* in the History Tree, select **RhombicCell**.
2. On the **Draw** ribbon tab, click  **Move**.
3. Click any arbitrary grid point or corner vertex of the *RhombicCell* to specify the first point of the move vector.
4. Using the coordinate text boxes in the status bar, specify the second point of the move vector, as follows. Then press **Enter**.
 - **dX = 0**
 - **dY = 0**
 - **dZ = -2**

The vertical elevation of the *RhombicCell* is reduced by 2 cm.

5. Verify that the **Move Vector** in the **Command** tab of the docked *Properties* window matches the following figure:

	Name	Value	Unit	Evaluated Value
	Command	Move		
	Coordinate Sys...	Global		
	Move Vector	0,0,-2	cm	0cm, 0cm, -2cm
	Suppress Com...	<input type="checkbox"/>		

Figure 3-17: Move Vector Properties

6. Clear the selection.

The new *RhombicCell* position should place half of it above the *Aperture* and half below:

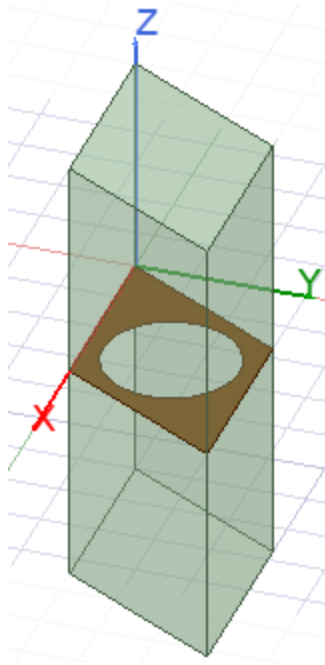

Figure 3-18: RhombicCell Repositioned

Note:

The combination of the rhombic shape of the model and the trimetric viewpoint make the aperture look like a narrow ellipse. However, it is perfectly circular (as a *Top* or *Bottom* viewpoint orientation would make apparent).

Assign Primary and Secondary Boundaries

After completing the geometry for the FSS unit cell, you can now assign the Primary and Secondary boundaries.

Since you should have already completed the primary and secondary boundary definitions for the *Antenna Array* portion of this getting started guide, this time, the instructions are less explicit. If you need help with the vector definitions or knowing when to reverse the V vector, review the instructions on the [Array Antenna > Assign Primary and Secondary Boundaries](#) topic.

First Pair:

For this procedure, refer to the figure, [Primary1 and Secondary1 Boundaries Applied](#).

1. Rotate the model viewpoint somewhat about the Z axis so that the faces to receive the boundary assignments don't overlap.
2. Press **F** to begin the *Face Selection* mode.

3. Select the face where the *Primary* boundary is to be applied (labeled and shown without the green shading in the reference figure). This face is the +X side of the *RhombicCell* object.
4. Using the menu bar, click **HFSS > Boundaries > Assign > Coupled > Primary**.
The *Primary Boundary* dialog box appears.
5. Keep the **Name** as **Primary1**.
6. Define the *U Vector* and *V Vector direction* to be consistent with the reference figure.
7. Click **OK**.
8. Select the face where the *Secondary* boundary is to be applied (the -X side of the *RhombicCell* object).
9. Using the menu bar, click **HFSS > Boundaries > Assign > Coupled > Secondary**.
10. Keep the **Name** as **Secondary1**.
11. Choose **Primary1** from the **Primary Boundary** drop-down menu.
12. Define the *U Vector* and *V Vector direction* to be consistent with the reference figure.
13. Click **Next**.
14. Keep the default *Phase Delay* settings and click **Finish** to apply the boundary.

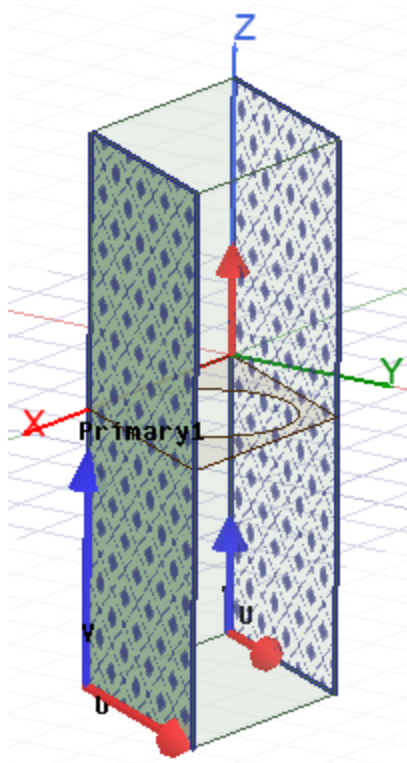



Figure 3-19: *Primary1* and *Secondary1* Boundaries Applied

Second Pair:

For this procedure, refer to the figure, [Primary2 and Secondary2 Boundaries Applied](#).

1. On the **Draw** ribbon tab, click  **Orient** to restore the default Trimetric view of the model.
2. Select the face where the *Primary* boundary is to be applied (labeled and shown without the green shading in the reference figure). This face is the +Y side of the *RhombicCell* object.
3. Right-click in the Modeler window and choose **Assign Boundary** > **Coupled** > **Primary** from the shortcut menu.
4. Keep the **Name** as **Primary2**.
5. Define the *U Vector* and *V Vector direction* to be consistent with the reference figure.
6. Click **OK**.
7. Select the face where the *Secondary* boundary is to be applied (the -Y side of the *RhombicCell* object).
8. Right-click in the Modeler window and choose **Assign Boundary** > **Coupled** > **Secondary**.
9. Keep the **Name** as **Secondary2**.
10. Choose **Primary2** from the **Primary Boundary** drop-down menu.
11. Define the *U Vector* and *V Vector direction* to be consistent with the reference figure.
12. Click **Next**.
13. Keep the default *Phase Delay* settings and click **Finish** to apply the boundary.

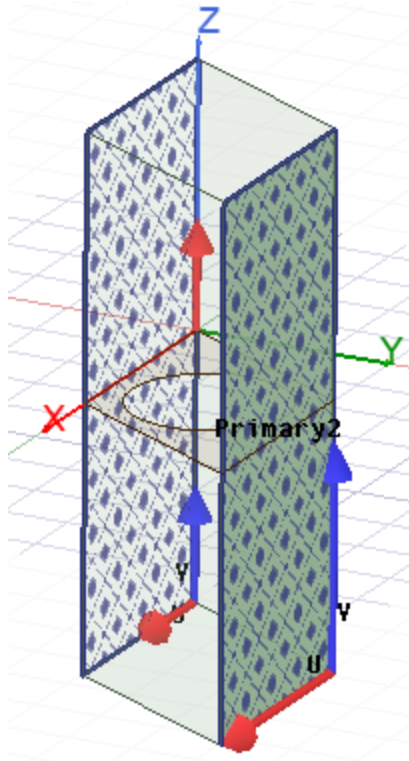

Figure 3-20: *Primary2* and *Secondary2* Boundaries Applied

14. Clear the selection.

Assign the Perfect E Boundary

You will now assign a Perfect E boundary to the aperture.

1. Press **O** to enter *Object Selection* mode.
2. Select the aperture.
3. From the menu bar, select **HFSS > Boundaries > Assign > Perfect E**.
4. Leave the **Name** as *PerfE1*, **Infinite Ground Plane** *not* selected, and click **OK**.

The *PerfE1* boundary appears on the aperture as shown in following figure:

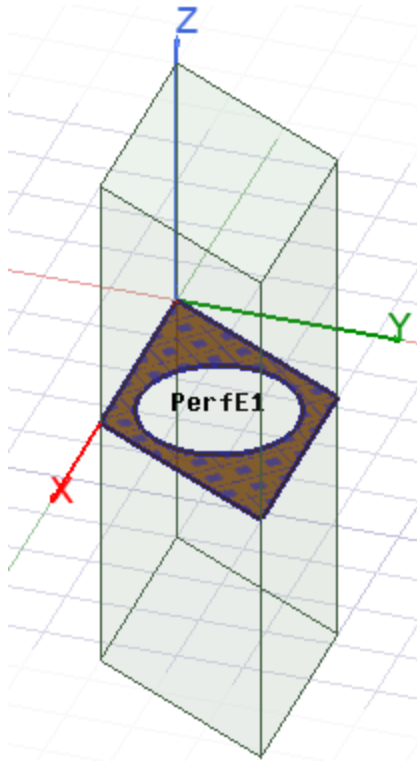

Figure 3-21: *PerfE1* Boundary Applied

5. Clear the selection.

Assign the Floquet Ports

You are all set to assign the Floquet ports to the top and bottom faces of the model.

1. Press **F** to return to the *Faces* selection mode.
2. Select the **top** face of the model and, on the menu bar, click **HFSS > Excitations > Assign > Port > Floquet Port**.

The *Floquet Port : General* dialog box appears.

3. From the **A Direction** drop-down menu, select **New Vector**.

The *Measure Data* and *Create Line* dialog boxes appear; the latter one instructs you to draw the vector in the plane of the face.

4. Draw the **a** vector parallel to the X axis and pointing in the +X direction, as shown in the figure, [FloquetPort1 Vectors](#).

Note:

Click the corner vertex that lies on the Z-axis first and then, click the corner in the +X direction to draw the **a** vector. The *Floquet Port : General* dialog box reappears after the second click.

5. From the **B Direction** drop-down menu, select **New Vector**.
6. Draw the **b** vector starting at the same corner vertex as the **a** vector and ending at the corner diagonally opposite the endpoint of the **a** vector, as shown in the following figure:

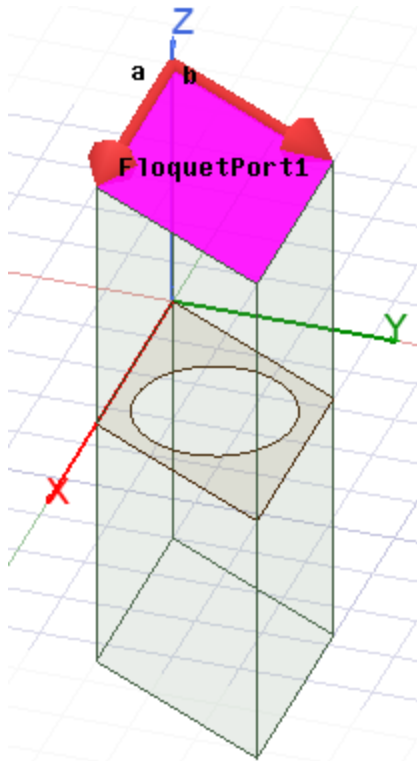

Figure 3-22: FloquetPort1 Vectors

The *Floquet Port : General* dialog box reappears after you click the second vertex.

7. Click **Next**.
8. Click **Modes Calculator** for assistance in setting up the port modes.
9. In the *Mode Table Calculator*, specify **20** for the **Number of Modes** and **20 GHz** for the **Frequency**, as shown in the following figure. Then, click **OK**.

Number of Modes:

Parameters For Mode Selection

Frequency:

Scan Angles:

Phi

Start

Stop

Step Size

Theta

Start

Stop

Step Size

Figure 3-23: Mode Table Calculator

The table in the *Floquet Port : Modes Setup* dialog now has the following calculated values:

	Mode	Polarization State	m	n	Attenuation (db/length)
	1	TE	0	0	0.00
	2	TM	0	0	0.00
	3	TE	-1	0	1.15
	4	TE	1	0	1.15
	5	TE	-1	-1	1.15
	6	TE	1	1	1.15
	7	TM	1	1	1.15
	8	TM	1	0	1.15
	9	TM	-1	-1	1.15
	10	TM	-1	0	1.15
	11	TE	0	-1	1.16
	12	TE	0	1	1.16
	13	TM	0	-1	1.16
	14	TM	0	1	1.16
	15	TE	2	1	51.53
	16	TE	-2	-1	51.53
	17	TM	2	1	51.53
	18	TM	-2	-1	51.53
	19	TE	1	-1	51.53
	20	TE	-1	1	51.53

Figure 3-24: Calculated Attenuation values

10. Reduce the **Number of Modes** entry to **14** to eliminate the last six modes from the table.

Note:

The reasoning behind trimming the modes is given in the [Omission of Modes with Large Attenuation](#) section immediately below this procedure.

11. Click **Next**.

The *Floquet Port : Post Processing* dialog box appears.

12. Select the **Deembed** option and specify a **Distance** of **2 cm**.

Deembed Settings

Deembed Distance:

Positive distance will deembed into the port.

Figure 3-25: Post Processing Settings

13. Click **Next** to advance to the *Floquet Port : 3D Refinement* dialog box.
14. Click **Clear Refinement Selections** and then select the **Affects Refinement** option only for **Mode 1**.
15. Click **Finish**.

FloquetPort1 appears under *Excitations* in the Project Manager.

16. Select the **bottom** face of the model, and repeat this procedure to set up the second Floquet port.

Note:

The vector directions, modes, and all other options should be identical for FloquetPort2, except that they are applied at the bottom face of the *RhombicCell* object. The vectors and modes should be copied automatically from the FloquetPort1 setup. However, you will have to repeat the *Deembed* and *3D Refinement* settings (steps 10 through 14).

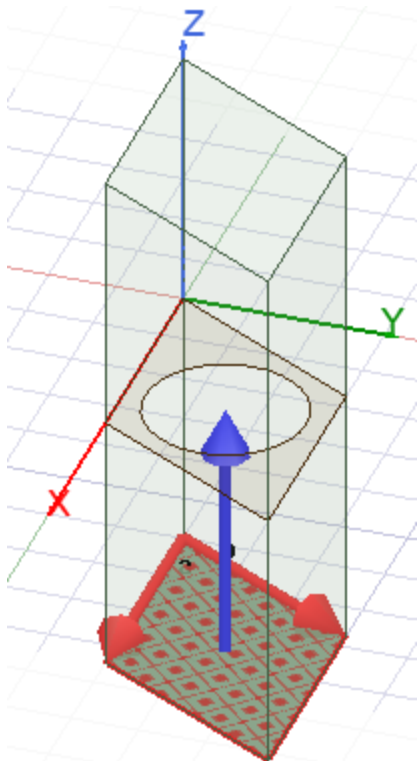



Figure 3-26: FloquetPort2 Applied

17. Clear the selection and  Save your model.

Omission of Modes with Large Attenuation:

When defining the Floquet port modes, you trimmed the last six modes from the table. Since the attenuation is high for modes above the 14th one, the results of those modes would be insignificant. Specifically, for *Deembed Distance* = 2 cm, the total attenuation from the aperture to the port = $51.53 \text{ db/cm} * 2 \text{ cm} = 103.06 \text{ db}$. This is a very large amount of attenuation. Thus, it is reasonable to neglect modes 15 through 20 by eliminating them from the analysis.

Set Up the Analysis

1. On the **Simulation** ribbon tab, click  **Setup > Advanced**.

The *Driven Solution Setup* dialog box appears.

2. Under the **General** tab, enter the settings shown in the following figure:

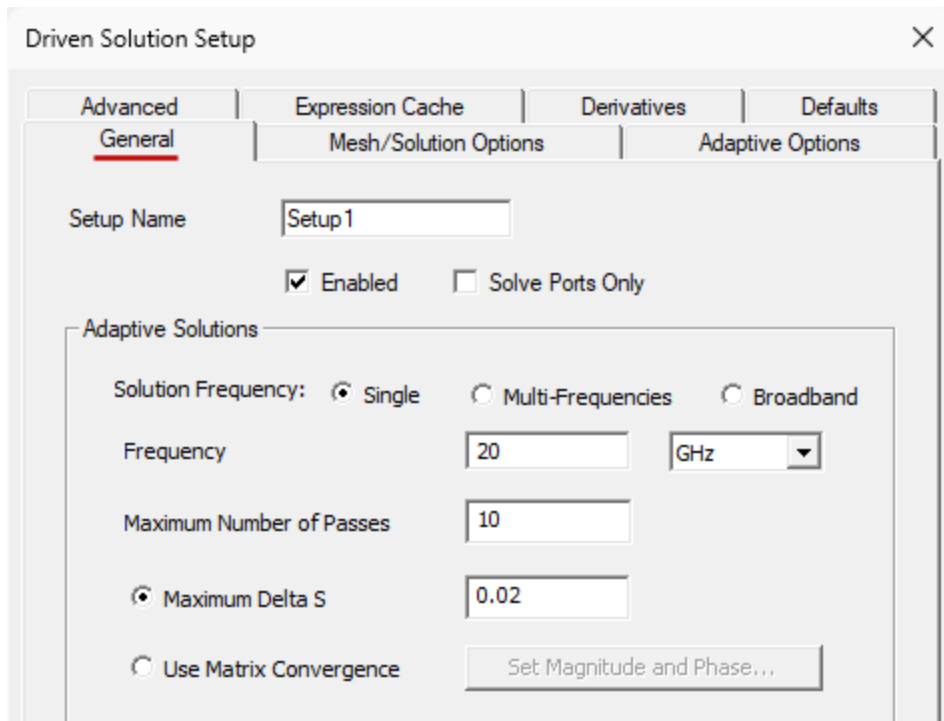

Figure 3-27: Driven Solution Setup – General Tab

3. Select the **Mesh/Solution Options** tab and, in the *Initial Mesh Options* section, enter the settings shown in the following figure:

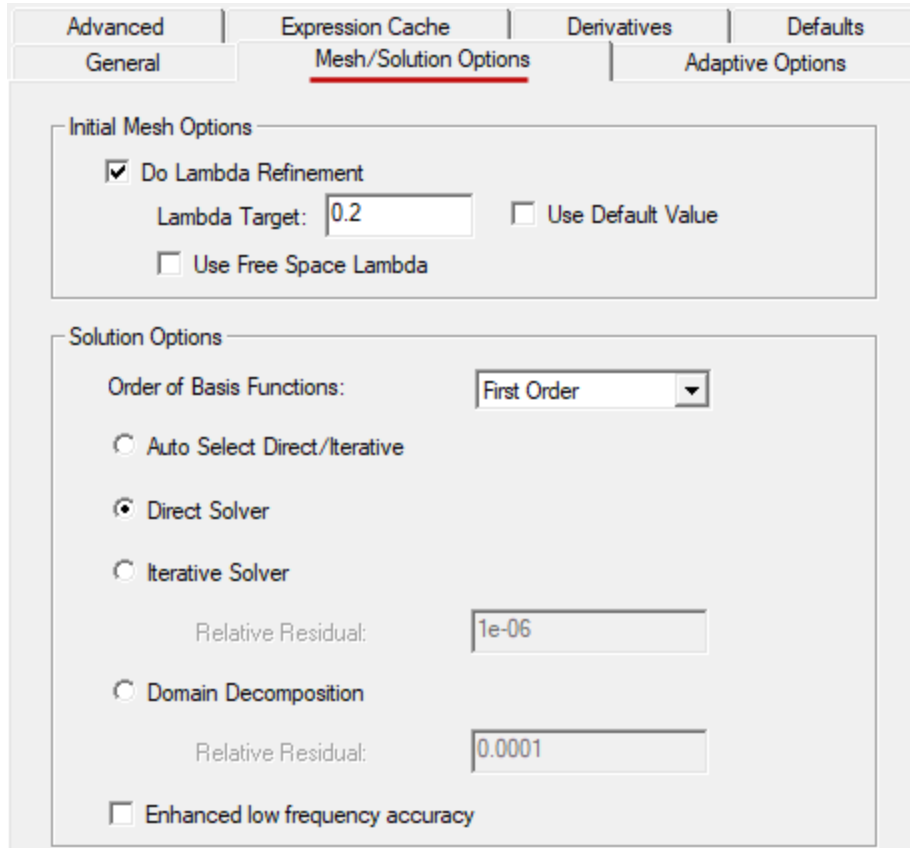

Figure 3-28: Driven Solution Setup – Mesh/Solution Options Tab

4. Click **OK**.

The *Edit Frequency Sweep* dialog box appears automatically when you complete the solution setup for a model that already has at least one port assigned. Keep this dialog box open. You will define the frequency sweep in the next procedure.

Add Frequency Sweep and Analyze

As a result of adding a solution setup in the previous topic, the *Edit Frequency Sweep* dialog box should already be open. Define the sweep as follows:

1. Under the **General** tab, enter the settings shown in the following figure:

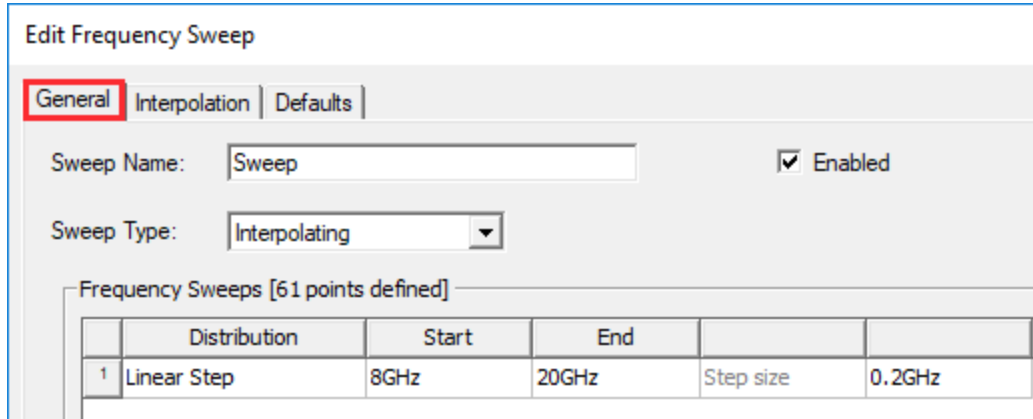

Figure 3-29: Edit Frequency Sweep Dialog Box – General Tab

2. Select the **Interpolation** tab and enter the settings shown in following figure:

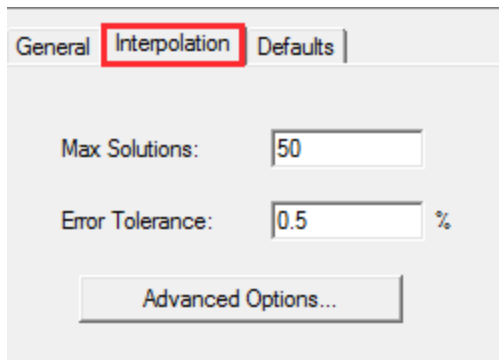

Figure 3-30: Edit Frequency Sweep Dialog Box – Interpolation Tab

3. Click **Advanced Options**.

The *Interpolating Sweep Advanced Options* dialog box appears.

4. Enter the settings shown in the following figure:

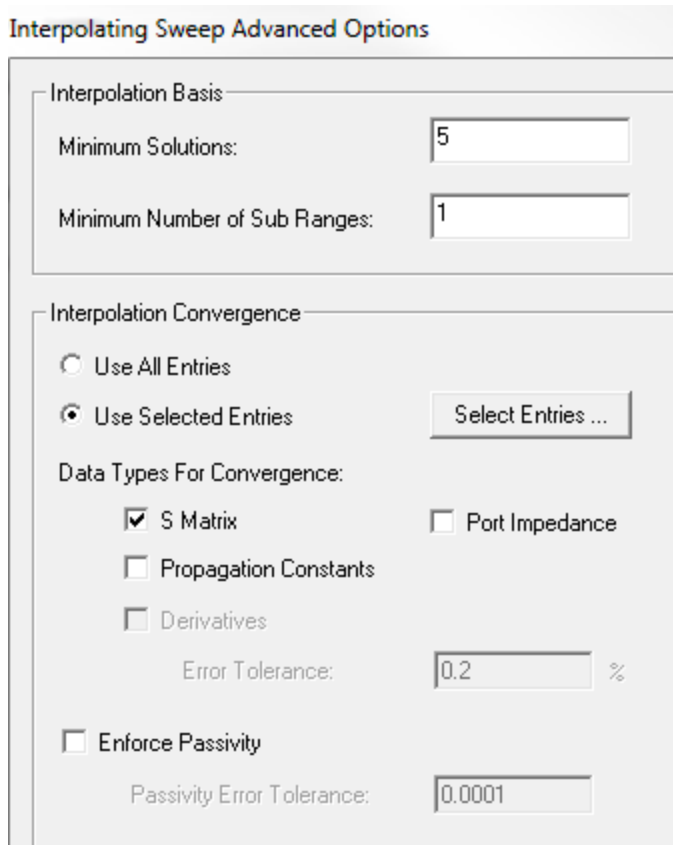

Figure 3-31: Interpolating Sweep Advanced Options

5. Click **Select Entries**.

The *Interpolation Basis Convergence* dialog box opens.

6. Ensure that **All** is selected from both the **Entry Selection** and **Mode Selection** drop-down menus.
7. Scroll down until you can see the **FloquetPort2:1** row of the table, click in the **FloquetPort1:1** column on that row, and choose **ON** from the drop-down menu:

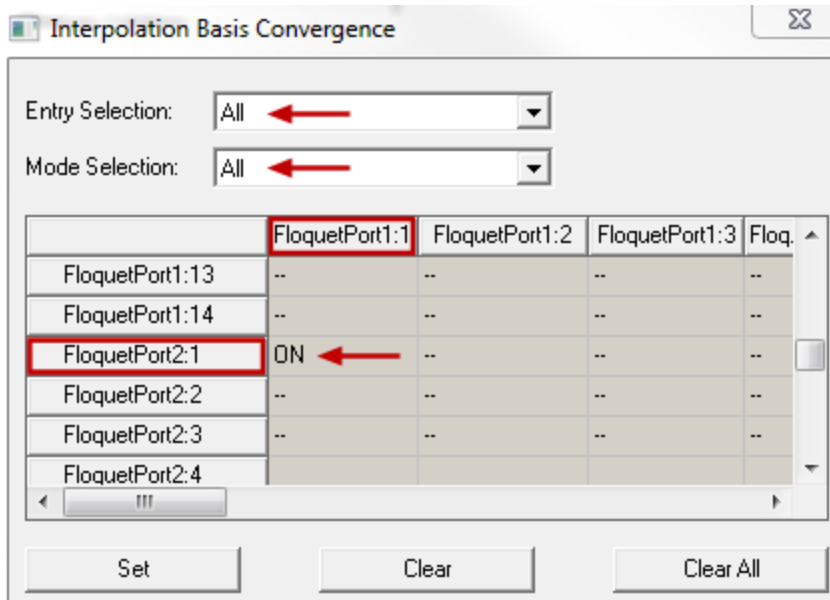



Figure 3-32: Interpolation Basis Convergence Dialog Box

- Click **OK** to close the *Interpolation Basis Convergence* dialog box, **OK** to close the *Interpolating Sweep Advanced Options* dialog box, and **OK** to close the *Edit Frequency Sweep* dialog box.

- On the **Simulation** ribbon tab, click  **Validate**.

The *Validation Check* should complete successfully (with no warnings or errors reported).

Note:

For most HFSS projects, do not be alarmed if you see any warnings in the *Message Manager* window. Some of these warnings are informational messages only. They may not always require you to perform any action. However, for this exercise, the *Message Manager* must not display any error or warning messages; the *Validation Check* dialog box must show a green check mark at each of the listed options, indicating that you can analyze the design.

- Click **Close**.

- On the **Simulation** ribbon tab, click  **Analyze All**.

The solution process begins and should finish in a minute or two, depending on your computer system.

Evaluate the Results

Now that you've solved the design, it's time to evaluate the results by generating reports (2D plots). You will also view the port field displays (vector overlays) for several of the Floquet port modes.

The following topics are covered in this section:

- Phase Transmission vs. Frequency Plot
- S Parameters vs. Frequency Plot
(specifically, Transmission and Reflection vs. Frequency)
- Port Field Displays for Modes

Phase Transmission vs. Frequency

1. On the **Results** ribbon tab, click  **Modal Solution Data Report** >  **2D**.

The *Report* dialog box appears.

2. The **Context** portion of the dialog box should match the following figure:

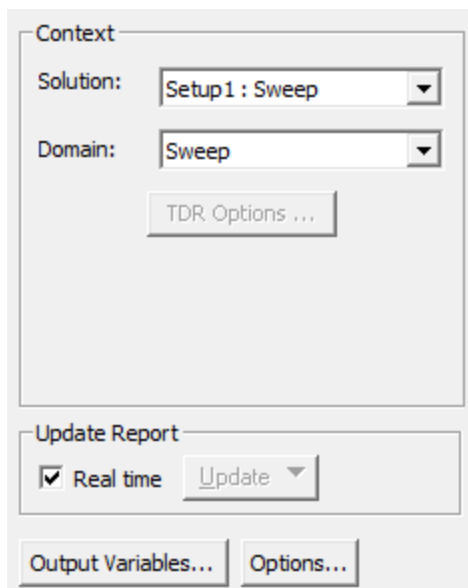

Figure 3-33: Context Portion of the Report Dialog Box

3. Under the **Trace** tab, specify the settings shown in the following image so that the **Y** axis is populated with the expression for phase transmission:

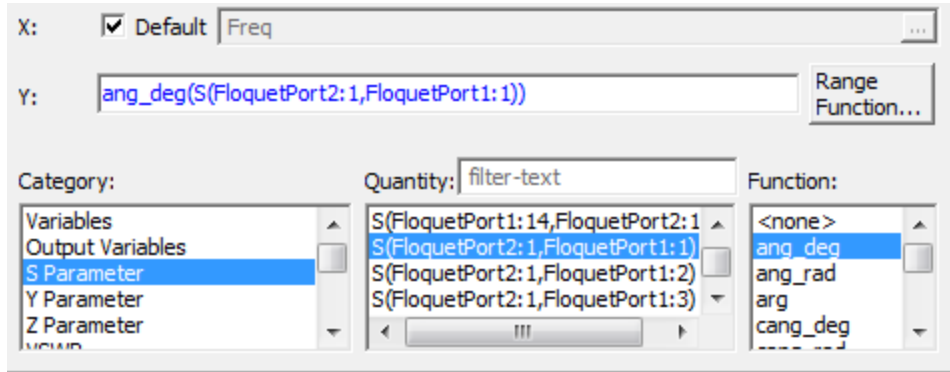

Figure 3-34: Report Dialog Box – Trace Tab

Note:

Keep the default value of **X** (*Freq*).

4. Click **New Report** but leave the *Report* dialog box open.

HFSS generates the plot for Phase Transmission versus Frequency. See the following figure, to which annotations have been added. Clearly, from the plot we can see that the phase angle changes as the waves pass through the FSS cell at varying frequencies.

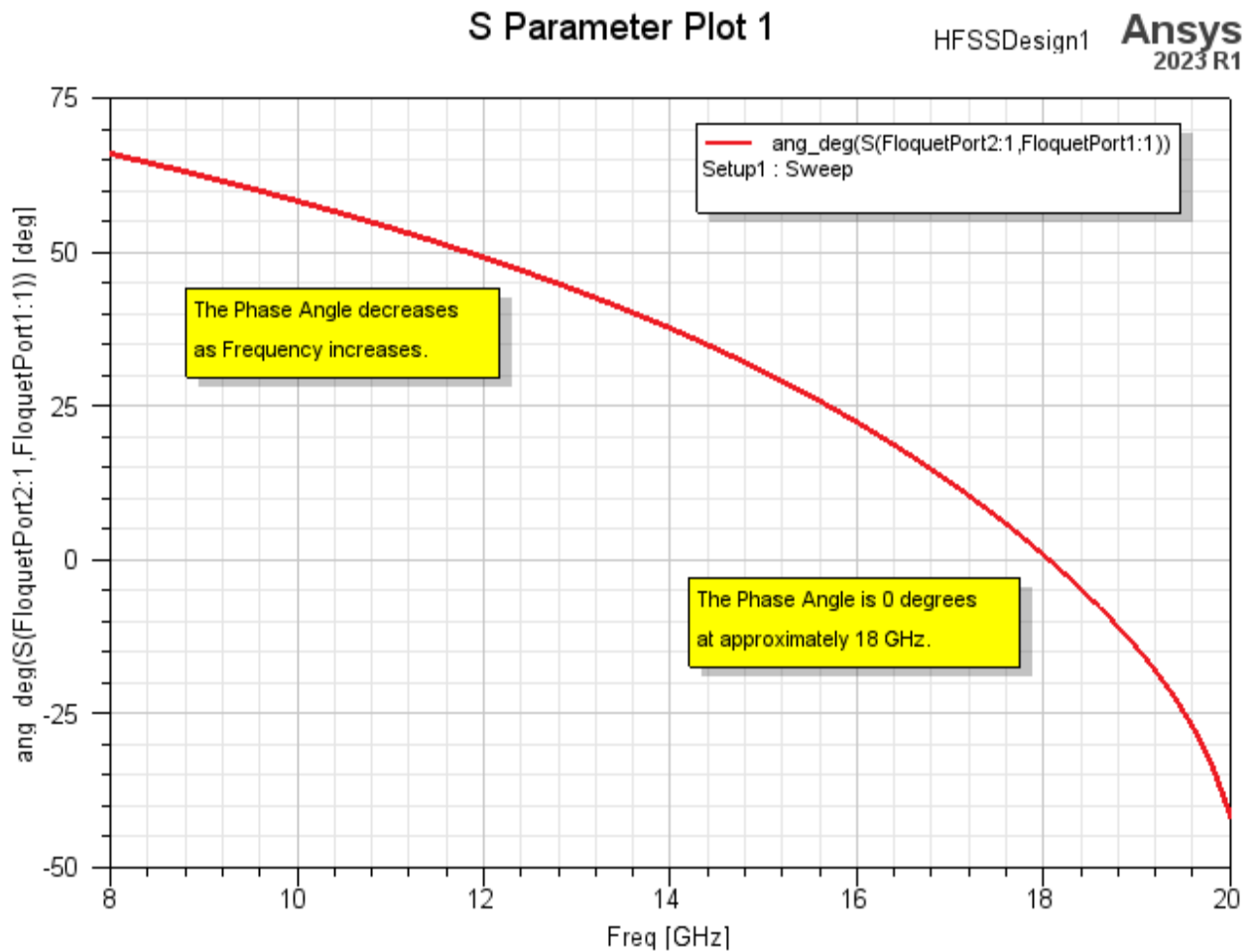

Figure 3-35: Phase Transmission vs. Frequency Plot

S Parameters vs. Frequency

In this plot, you will choose the S parameters that represent transmission and reflection versus frequency.

1. If you did not keep the Report dialog box open from the previous procedure, click 

Modal Solution Data Report >  **2D** on the **Results** ribbon tab to reopen it.

2. Under the **Trace** tab of the *Report* dialog box, **S Parameter** should still be selected in the **Category** list.
3. In the **Quantity** list, select **S(FloquetPort1:1,FloquetPort1:1))** and **S(FloquetPort1:1,FloquetPort2:1))**.

Note:

The list of port and mode combinations is long, so choose carefully.

4. In the **Function** list, select **dB**.
5. Click **New Report** and click **Close**.

The transmission and reflection curves are generated. The figure below has been annotated to clearly indicate the *Transmission* and *Reflection* traces:

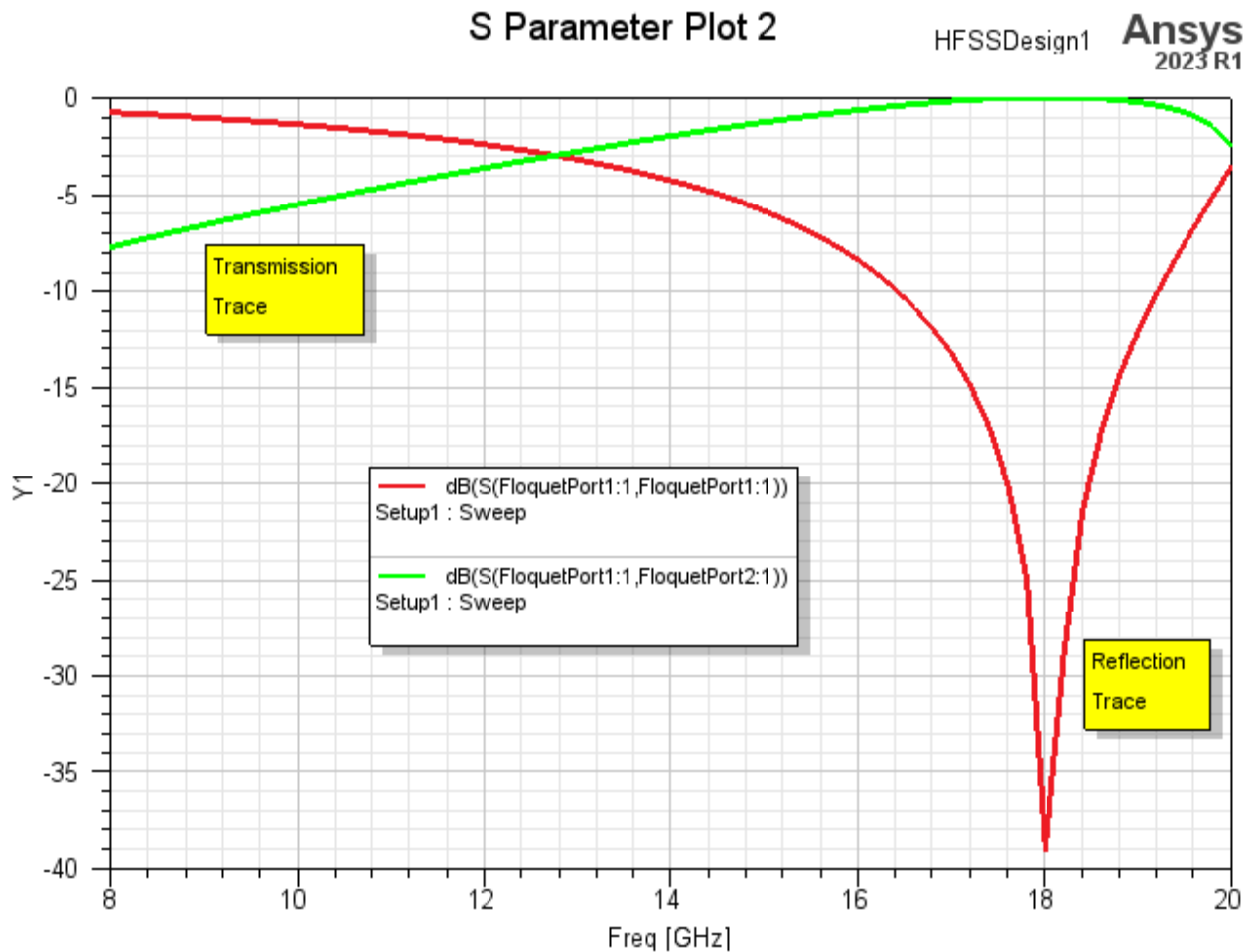

Figure 3-36: Transmission & Reflection vs. Frequency

Note:

The point of strongest transmission through the FSS cell and least reflection occurs at 18 GHz.

Port Field Displays for Modes

1. Return to the Modeler window so that you can review the port field displays for the calculated modes.
2. Under *Port Field Display* in the Project Manager, there are mode lists for *FloquetPort1* and *FloquetPort2*. You can expand either port's branch and select a mode to see a vector overlay of the port field associated with that mode.

Below are the field displays for the first four modes for each of the two Floquet ports:

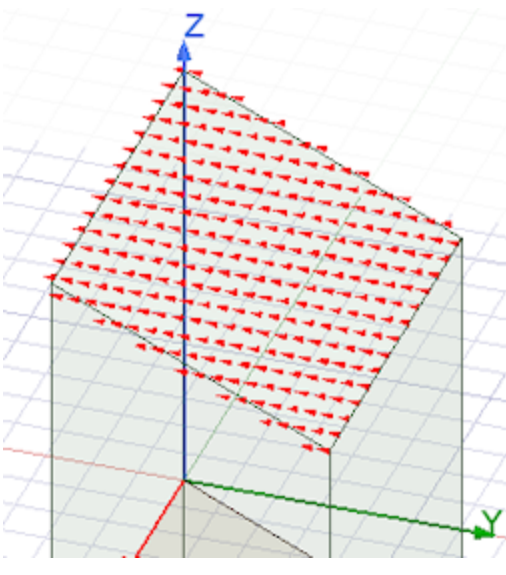
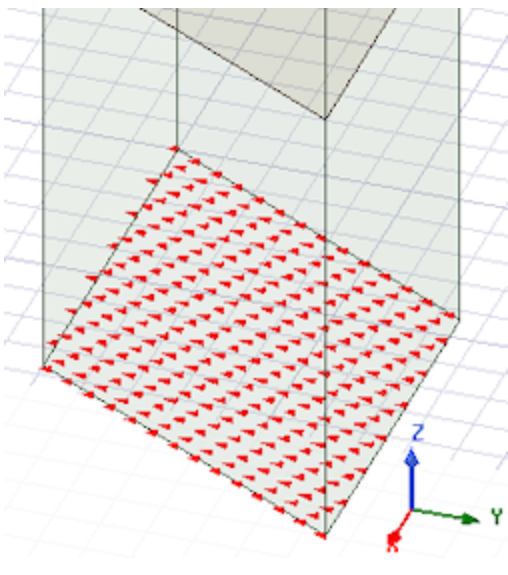
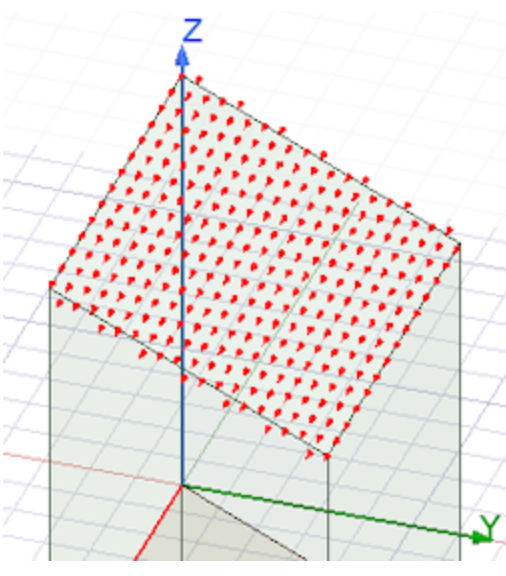
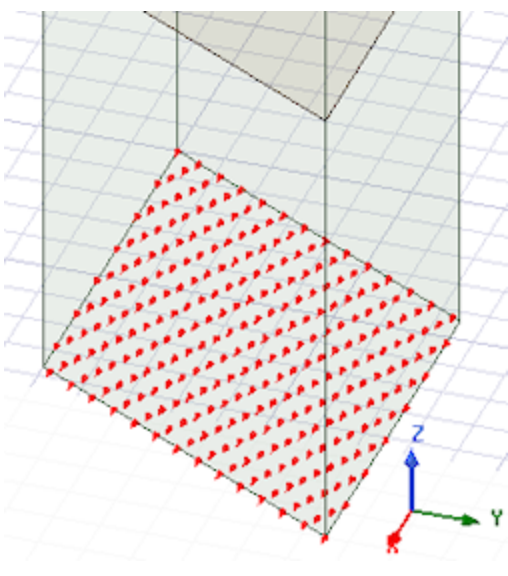
Mode	FloquetPort1	FloquetPort2
1		
2		

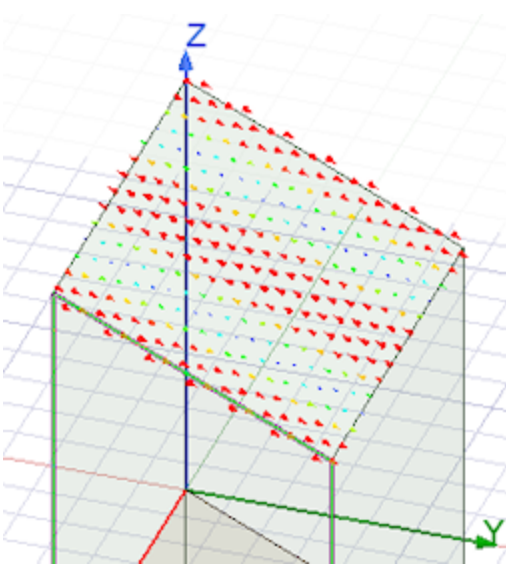
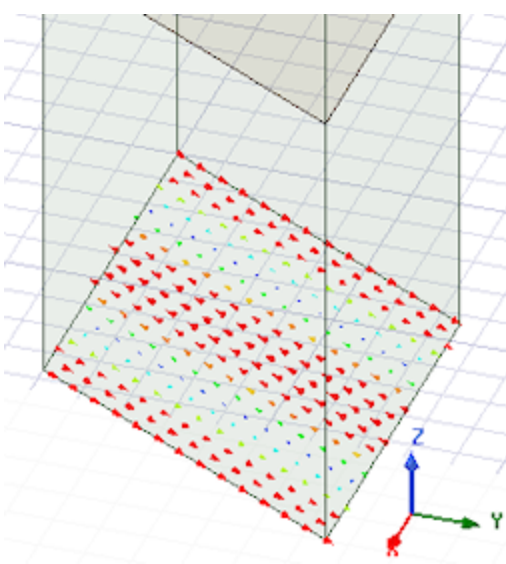
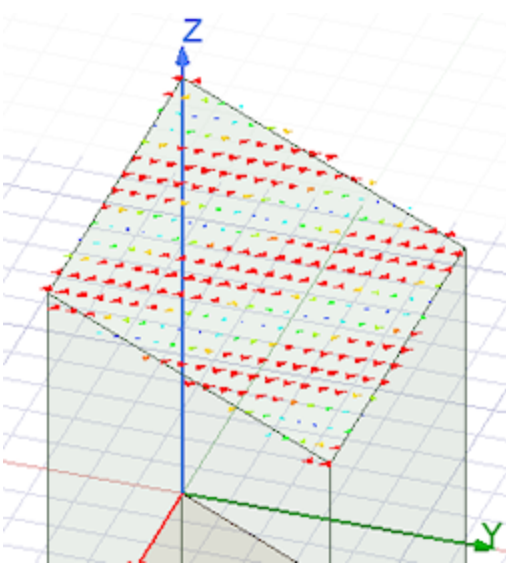
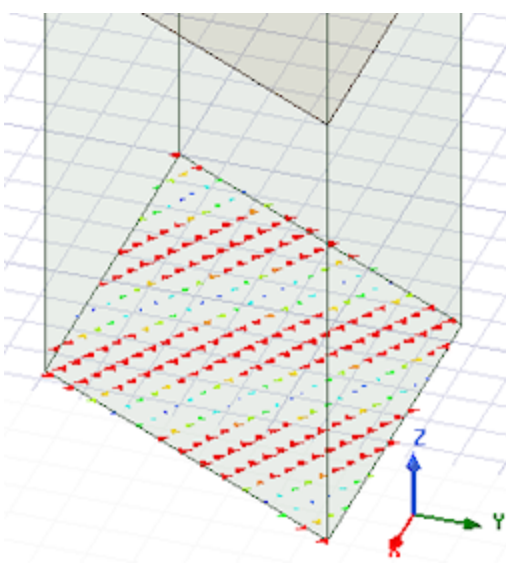
Mode	FloquetPort1	FloquetPort2
3		
4		

4 - Optionally, Restore Current View Orientations

You have completed this getting started guide.

If you prefer to use the new view orientations implemented in version 2024 R1 of the Ansys Electronics Desktop application, clear the *Use Legacy View Orientation* option as follows:

1. From the menu bar, click **View > Options**.

The *3D UI Options* dialog box appears.

2. Ensure that **Enable Legacy View Orientation** is cleared:

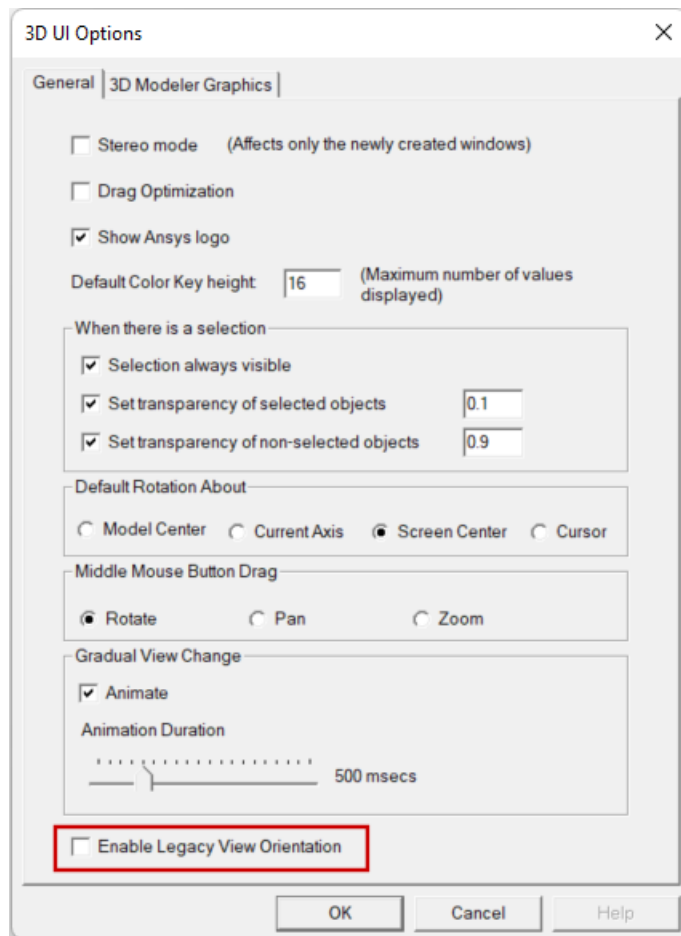

3. Click **OK**.

The settings in the 3D UI Options dialog box are global. Your choice is retained for all future program sessions, projects, and design types that use the 3D Modeler or that produce 3D plots of results.

You can now save and close this project.